

**DIRECT SUPPORT AND GENERAL SUPPORT
MAINTENANCE MANUAL
FOR
GRENADES**

Distribution Statement A - Approved for public release; distribution is unlimited.

DEPARTMENTS OF THE ARMY AND THE NAVY

July 1993

WARNINGS

ASSURE PROPER CONDITION OF SAFETY DEVICES BEFORE REMOVING GRENADE FROM CONTAINERS. DO NOT LIFT OR HOLD GRENADE BY SAFETY DEVICES. EXERCISE CARE TO AVOID ROUGH HANDLING OR DROPPING OF GRENADES.

DO NOT MIX AMMUNITION LOTS.

KEEP WORK AREA NEAT, CLEAN, AND ORDERLY.

WEAR FACE SHIELD AND LEATHER GLOVES. EXERCISE CARE TO AVOID INJURY FROM SHARP METAL EDGES WHEN REMOVING TEAR STRIP FROM OR HANDLING OPEN METAL CONTAINERS OR WHEN CUTTING METAL STRAPPING.

LIMIT NUMBER OF GRENADES, FUZES AND AMOUNT OF FLAMMABLE LIQUID AT WORK SITE TO AMOUNT NECESSARY FOR SAFE AND EFFICIENT OPERATIONS.

ACCOMPLISH ALL OPERATIONS INVOLVING ENAMEL OR SOLVENTS IN WELL VENTILATED AREA. KEEP ALL SOLVENTS IN APPROVED PLUNGER TYPE SAFETY CAN. WEAR DISPOSABLE PLASTIC GLOVES TO PREVENT LIQUID ENAMEL AND SOLVENT FROM COMING IN CONTACT WITH SKIN. AVOID INHALING VAPORS FROM ENAMEL OR SOLVENTS.

KEEP HAND GRENADE FUZES IN SECTIONALIZED SHIELDED TRAY TO PROTECT DETONATOR AT ALL TIMES WHEN REMOVED FROM GRENADE LOADING ASSEMBLY.

NEVER GRASP FUZES BY DETONATOR.

**CHANGE
NO. 6**

**HEADQUARTERS
DEPARTMENT OF THE ARMY
WASHINGTON, DC, 10 March 2006**

**DIRECT SUPPORT AND GENERAL SUPPORT
MAINTENANCE MANUAL
FOR
GRENADES**

DISTRIBUTION STATEMENT A: Approved for public release; distribution is unlimited.

TM 9-1330-200-34, dated 15 July 1993, is changed as follows:

1. File this change sheet in front of the publication for reference purposes.
2. Remove old pages and insert new pages as indicated below.
3. New or changed material is indicated by a vertical bar in the margin of the page.
4. Added or revised appendixes are indicated by a vertical bar adjacent to the appendix title.

Remove Pages

A and B
i and ii
4-1 and 4-2
4-7 and 4-8
5-1 thru 5-4
5-6.1 and 5-6.2
A-1 and A-2
DA Form 2028-2

Insert Pages

A and B
i and ii
4-1 and 4-2
4-7 and 4-8
5-1 thru 5-4
5-6.1 and 5-6.2
A-1 and A-2
DA Form 2028

By Order of the Secretary of the Army:

Official:



JOYCE E. MORROW
Administrative Assistant to the
Secretary of the Army
0533902

PETER J. SCHOOMAKER
General, United States Army
Chief of Staff

DISTRIBUTION: To be distributed in accordance with the initial distribution number (IDN) 400333, requirements for TM 9-1330-200-34.

CHANGE

NO. 5

HEADQUARTERS
DEPARTMENT OF THE ARMY
Washington, DC, 29 November 2002

**DIRECT SUPPORT AND GENERAL SUPPORT
MAINTENANCE MANUAL
FOR
GRENADES**

DISTRIBUTION STATEMENT A: Approved for public release; distribution is unlimited.

TM 9-1330-200-34, dated 15 July 1993, is changed as follows:

1. File this change sheet in front of the publication for reference purposes.
2. Remove old pages and insert new pages as indicated below.
3. New or changed material is indicated by a vertical bar in the margin of the page.
4. Added or revised illustrations are indicated by a vertical bar adjacent to the illustration identification number.

Remove pages

A and B
5-5 and 5-6

Insert pages

A and B
5-5 and 5-6

By Order of the Secretary of the Army:

Official:

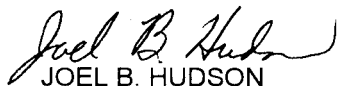

JOEL B. HUDSON
*Administrative Assistant to the
Secretary of the Army*

0231310

ERIC K. SHINSEKI
*General, United States Army
Chief of Staff*

Distribution:

To be distributed in accordance with IDN 400333, requirements for TM 9-1330-200-34.

CHANGE
NO. 4

HEADQUARTERS
DEPARTMENT OF THE ARMY
Washington, DC, 15 March 2002

**DIRECT SUPPORT AND GENERAL SUPPORT
MAINTENANCE MANUAL
FOR
GRENADES**

DISTRIBUTION STATEMENT A: Approved for public release; distribution is unlimited.

TM 9-1330-200-34, dated 15 July 1993, is changed as follows:

1. File this change sheet in front of the publication for reference purposes.
2. Remove old pages and insert new pages as indicated below.
3. New or changed material is indicated by a vertical bar in the margin of the page.
4. Added or revised illustrations are indicated by a vertical bar adjacent to the illustration identification number.

Remove pages

A and B
5-3 and 5-4

Insert pages

A and B
5-3 and 5-4

By Order of the Secretary of the Army:

Official:

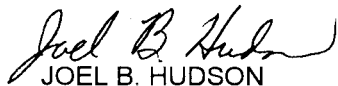

JOEL B. HUDSON
*Administrative Assistant to the
Secretary of the Army*

0206404

ERIC K. SHINSEKI
*General, United States Army
Chief of Staff*

Distribution:

To be distributed in accordance with IDN 400333, requirements for TM 9-1330-200-34.

CHANGE

NO. 3

HEADQUARTERS
DEPARTMENT OF THE ARMY
Washington, DC, 28 December 2001

**DIRECT SUPPORT AND GENERAL SUPPORT
MAINTENANCE MANUAL
FOR
GRENADES**

DISTRIBUTION STATEMENT A: Approved for public release; distribution is unlimited.

TM 9-1330-200-34, dated 15 July 1993, is changed as follows:

1. Remove old pages and insert new pages as indicated below.
2. New or changed material is indicated by a vertical bar in the margin of the page.
3. Added or revised illustrations are indicated by a vertical bar adjacent to the illustration identification number.

Remove pages	Insert pages
A and B	A and B
i and ii	i and ii
4-7 and 4-8	4-7 and 4-8
5-1 and 5-2	5-1 and 5-2
5-5 and 5-6	5-5 and 5-6
None	5-6.1 and 5-6.2
5-7 and 5-8	5-7 and 5-8
A-1 and A-2	A-1 and A-2

File this change sheet in front of the publication for reference purposes.

By Order of the Secretary of the Army:

Official:

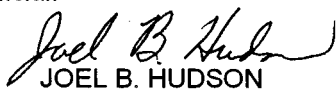
JOEL B. HUDSON
Administrative Assistant to the
Secretary of the Army

ERIC K. SHINSEKI
General, United States Army
Chief of Staff

0134405

Distribution:

To be distributed in accordance with IDN 400333, requirements for TM 9-1330-200-34.

Change)
)
)
 No. 2)

HEADQUARTERS
 DEPARTMENTS OF THE ARMY
 AND THE NAVY
 Washington, DC, 16 June 1995

**DIRECT SUPPORT AND GENERAL SUPPORT MAINTENANCE MANUAL
 FOR
 GRENADES**

TM 9-1330-200-34/TM 1330-34/1, 15 July 1993, is changed as follows:

1. Remove old pages and insert new pages as indicated below. New or changed material is indicated by a vertical bar in the margin of the page. Added or revised illustrations are indicated by a vertical bar adjacent to the identification number.

Remove pages

A and B
 i and ii
 5-3 and 5-4

Insert pages

A and B
 i and ii
 5-3 and 5-4

2. File this change sheet in front of the publication for reference purposes.

By Order of the Secretaries of the Army and the Navy:

Official:

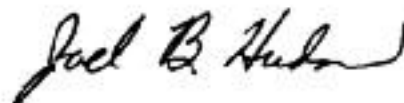

JOEL B. HUDSON

*Acting Administrative Assistant to the
 Secretary of the Army*

GORDON R. SULLIVAN
*General, United States Army
 Chief of Staff*

RONALD D. ELLIOTT

Executive Director

Marine Corps Systems Command

Distribution:

Army:

To be distributed in accordance with DA Form 12-40-E, Block 0333, requirements for TM 9-1330- 200-34/TM 1330-34/1.

Marine Corps:

MARCORPS CODE: BE plus 7000159(5)
 7000161(2)

CHANGE)
)
)
NO. 1)

HEADQUARTERS
DEPARTMENTS OF THE ARMY
AND THE NAVY
Washington, DC, 15 June 1994

**DIRECT SUPPORT AND GENERAL SUPPORT MAINTENANCE MANUAL
FOR
GRENADES**

TM 9-1330-200-34/TM 1330-34/1, 15 July 1993, is changed as follows:

1. Remove old pages and insert new pages as indicated below. New or changed material is indicated by a vertical bar in the margin of the page. Added or revised illustrations are indicated by a vertical bar adjacent to the identification number.

Remove pages

A and B
5-5 and 5-6

Insert pages

A and B
5-5 and 5-6

2. File this change sheet in front of the publication for reference purposes.

By Order of the Secretary of the Army:

Official:

MILTON H. HAMILTON
*Administrative Assistant to the
Secretary of the Army*
06817

GORDON R. SULLIVAN
*General, United States Army
Chief of Staff*

Distribution:

Army:

To be distributed in accordance with DA Form 12-40-E, Block #0333, requirements for TM 9-1330- 200-34/TM 1330-34/1.

Marine Corps:

MARCORPS CODE: BE plus 7000159(5)
7000161(2)

LIST OF EFFECTIVE PAGES

INSERT LATEST CHANGED PAGES. DESTROY SUPERSEDED PAGES.

NOTE The portion of the text affected by the changes is indicated by a vertical line in the outer margins of the page. Changes to illustrations are indicated by a vertical line adjacent to the identification number.

Dates of issue for original and changed pages are:

Original 0 15 July 1993	Change 4 15 March 2002
Change 1 15 June 1994	Change 5 29 November 2002
Change 2 16 June 1995	Change 6 10 March 2006
Change 3 28 December 2001	

TOTAL NUMBER OF PAGES IN THIS PUBLICATION IS 50, CONSISTING OF THE FOLLOWING:

Page No.	*Change No.	Page No.	*Change No.	Page No.	*Change No.
Cover	0				
Warning Page	0				
A	6				
B	0				
i and ii	6				
1-1 and 1-2	0				
2-1 and 2-2	0				
3-1 thru 3-10	0				
4-1	6				
4-2 thru 4-6	0				
4-7	6				
4-8	3				
5-1	6				
5-2	0				
5-3	2				
5-4	6				
5-5	5				
5-6	3				
5-6.1	3				
5-6.2	6				
5-7	3				
5-8 thru 5-16	0				
A-1 and A-2	6				
B-1 and B-2	0				

*Zero in this column indicates an original page

THIS PAGE INTENTIONALLY LEFT BLANK

TECHNICAL MANUAL)
No. 9-1330-200-34/)
TM 1330-34/1A)

DEPARTMENTS OF THE ARMY
AND THE NAVY
Washington, DC, 15 July 1993

**DIRECT SUPPORT AND GENERAL SUPPORT
MAINTENANCE MANUAL
FOR
GRENADES**

REPORTING ERRORS AND RECOMMENDING IMPROVEMENTS

You can help improve this manual. If you find any mistakes or if you know of a way to improve the procedures, please let us know. Mail your letter or DA Form 2028 (Recommended Changes to Publications and Blank Forms) located in the back of this manual directly to Logistics Research and Engineering Directorate (AMSRD-AAR-AIL-LS), U.S. Army RDECOM, Armament Research, Development and Engineering Center, Picatinny Arsenal, NJ 07806-5000. You may also send in your recommended changes via electronic mail or by fax. Our e-mail address is LSB@PICA.ARMY.MIL. Our fax number is DSN 880-4633, Commercial (973) 724-4633. A reply will be furnished to you.

	<u>Page</u>
CHAPTER 1. INTRODUCTION	
Section I. General	
1-1. Scope	1-1
1-2. Forms, Records and Reports	1-1
Section II. Description and Functioning	
1-3. General	1-1
Section III. Safety, Care, and Handling	
1-4. General	1-1
CHAPTER 2. TOOLS AND EQUIPMENT	
2-1. General	2-1
2-2. Tools and Equipment	2-1
2-3. Repair Parts	2-1
CHAPTER 3. MAINTENANCE INSTRUCTIONS	
3-1. General	3-1
3-2. Direct Support Maintenance	3-1
3-3. General Support Maintenance	3-1
3-4. Safety in Handling	3-1
3-5. Maintenance Planning	3-2
3-6. Work Schedules	3-5
3-7. Line Layout	3-5
3-8. Lot Numbers	3-5
3-9. Ammunition Data Card (DD Form 1650)	3-6

*This manual supersedes TM 9-1330-200-34/TM 1330-34/1, dated 1 December 1971, including all changes.

CHAPTER 4.	INSPECTION REQUIREMENTS	
	4-1. General	4-1
	4-2. Sample Selection	4-1
	4-3. Visual Inspection	4-1
	4-4. Evaluation of Grenade Defects	4-1
	4-5. Evaluation of Packing Material Defects	4-2
	4-6. Classification of Defects	4-3
	4-7. Disposition of Inspection Lots	4-7
CHAPTER 5.	MAINTENANCE PROCEDURES	
	5-1. General	5-1
	5-2. Maintenance Operational Procedures	5-1
APPENDIX A.	REFERENCES	A-1
APPENDIX B.	MAINTENANCE SUPPLIES	B-1

LIST OF ILLUSTRATIONS

<u>Figure No.</u>	<u>Title</u>	<u>Page</u>
3-1	Sample of standing operating procedures.....	3-4
3-2	Typical line layout.....	3-7
3-3	Ammunition data card (DD Form 1650).....	3-9
5-1	Application of masking tape to grenade.....	5-7
5-2	Grenade suspension device and rack.....	5-9
5-3	Spray painting of hand grenade.....	5-10
5-4	Spray painting of rifle grenade.....	5-11
5-5	Dip painting of grenade.....	5-12
5-6	Defuzing or torquing of hand grenade fuze.....	5-13
5-7	Placing fuze in packing support	5-14
5-8	Pitch-in barricade.....	5-16

LIST OF TABLES

<u>Table No.</u>	<u>Title</u>	<u>Page</u>
4-1	Wooden Boxes and Crates.....	4-2
4-2	Fiber Containers	4-3
4-3	Metal Containers	4-3
4-4	Lots Released for Issue and Use.....	4-7
4-5	Lots Released for Priority of Issue	4-7
5-1	Painting and Marking of Hand Grenade Bodies.....	5-2
5-2	Marking of Rifle Grenade Bodies	5-5
5-3	Painting and Marking of RP Smoke Screening Grenades.....	5-5
5-4	Painting and Marking of IR Smoke Screening Grenades.....	5-5
5-5	Painting and Marking of Simulant Screening Smoke Grenades	5-6
5-6	Painting and Marking of Screening TA M90 Grenades.....	5-6
5-7	Painting and Marking of Grenade, Discharger, Anti-Riot, Irritant, CS, L96A1	5-6.1
5-8	Painting and Marking of Grenade, Discharger, Anti-Riot, Practice, L97A1.....	5-6.1
5-9	Painting and Marking of Grenade, Launcher: Non-Lethal, Distraction, M98	5-6.2
5-10	Painting and Marking of Grenade, Launcher: Non-Lethal, Blunt Trauma, M99	5-6.2

CHAPTER 1 INTRODUCTION

Section I. GENERAL

1-1. SCOPE

a. This is one of a series of technical manuals (TM's) covering general and technical information, servicing, operation, and maintenance of subject materiel. Information in this manual is limited to responsibilities of direct and general support maintenance personnel (i.e., maintenance which is beyond the scope of the tools, equipment or supplies normally available to operator and organizational personnel).

b. Information for operator and organizational maintenance personnel is covered in TM 9-1330-200-12. This includes the Maintenance Supplies List in appendix B and the Maintenance Allocation Chart (MAC) in appendix C. Direct support and general support maintenance responsibilities apply as prescribed in the MAC.

1-2. FORMS, RECORDS AND REPORTS

a. *General.* Responsibility for complete and accurate accomplishments of forms, records, and reports rests upon the officers of all units maintaining subject material. The value of accurate documents

must be appreciated by all persons responsible for data compilation, maintenance, and use. Properly completed forms show the type and quantity of materiel to be inspected, repaired or used in repair, and provide work authorization. Completed forms serve as records for:

- (1) Condition of materiel inspected.
- (2) Maintenance work required.
- (3) Repair or replacement of materiel in hands of troops.
- (4) Delivery requiring maintenance.
- (5) Progress of work in shops.
- (6) Status of materiel repaired.

b. *Authorized Forms.* The forms generally applicable to units maintaining subject materiel are listed in appendix A. For a current listing of all forms, refer to DA Pam 25-30. Refer to DA Pam 738-750 for instructions on use and completion of all forms required for maintaining grenades.

Section II. DESCRIPTION AND FUNCTIONING

1-3. GENERAL

For description and functioning of all grenade items and accessories, refer to TM 43-0001-29.

Section III. SAFETY, CARE, AND HANDLING

1-4. GENERAL

Detailed information on safety, care and handling of all grenade items and accessories can be found in TM 9-1330-200-12, TM 9-1300-206, and FM 23-30.

THIS PAGE INTENTIONALLY LEFT BLANK

CHAPTER 2 TOOLS AND EQUIPMENT

2-1. GENERAL

Tools, equipment, and repair parts, in addition to those available to the using organization, are supplied to direct and general support maintenance units for maintaining hand and rifle grenades and accessories.

2-2. TOOLS AND EQUIPMENT

a. Tools and equipment having general application to this materiel are authorized for issue by tables of allowances (TA) and tables of organization and equipment (TOE).

b. TM 9-1330-200-12 lists special tools and equipment required by all levels of maintenance personnel. TOE 09484L000, TOE 09433L000, TOE

09633L000, SC 4940-95-CLA11 and SC 4925-95-CL-A03 serve as a basis for requisitioning.

c. Except as otherwise indicated in paragraphs 3-1 through 3-9, local fabrication of tools and equipment is not authorized.

2-3. REPAIR PARTS

TM 9-1330-200-12 lists repair parts required by all levels of maintenance personnel. Consumable parts used by direct and general support maintenance personnel are listed in appendix B of TM 9-1330-200-34.

THIS PAGE INTENTIONALLY LEFT BLANK

CHAPTER 3 MAINTENANCE INSTRUCTIONS

3-1. General

a. Direct support maintenance performed by conventional ammunition companies includes surveillance and limited maintenance of stocks under their control. This applies equally to grenade items and accessories. Maintenance operations include, but are not limited to the following:

- (1) Cleaning and protection of individual items and/or packing material.
- (2) Removal of light rust.
- (3) Minor repair of boxes, containers, and crates.
- (4) Spot painting and restenciling.

b. General support maintenance may require large-scale repainting and re-marking, repacking, disassembly, defuzing, and refuzing.

3-2. Direct Support Maintenance

a. Maintenance to be performed is of such magnitude as to require operational line setups. Ammunition companies are responsible for, and are equipped to perform recurring care and preservation-type operations on all conventional ammunition under their control. The companies are also responsible for providing technical assistance to using units. If conditions preclude performing on-site maintenance, user stocks will be removed to a more suitable location.

b. Companies are responsible for stocking of authorized replacement components, packing materials, and expendable supplies. Requisitions will be submitted to an Inventory Control Point (ICP) for those components and/or supplies not authorized for stockage. When feasible, items required for maintenance of stocks, such as fiber containers and wooden boxes, will be recovered during expenditures of ammunition.

3-3. General Support Maintenance

Maintenance at the general support level is comparable to that at the direct support level, except that it is on a larger scale. It also includes the following:

- a. Large-scale repacking, repainting, remarking, and repair of boxes.
- b. Removing defective fuzes from hand grenades and replacing with acceptable fuzes.
- c. Demilitarization of unserviceable items.
- d. Grouping and relotting of small lots or renovated lots.

3-4. Safety in Handling

- a. Handle grenades in accordance with requirements contained in TM 9-1330-200-12, in addition to general instructions in TM 91300-206.
- b. Do not lift or handle grenades by their safety pin pull ring.

WARNING

- **WHITE PHOSPHORUS (WP) SMOKE IS POISONOUS UPON PROLONGED OR REPEATED INHALATION, PARTICULARLY IN CONFINED SPACE.**
- **NORMAL CONCENTRATIONS IN OPEN AIR ARE NOT LIKELY TO BE HARMFUL.**

c. Have container of water close at hand for submerging items in case of WP leakage. Have readily available containers of 1 percent and 5 percent copper sulphate solution and box of baking soda.

d. Familiarize personnel with first aid procedures for WP burns.

(1) Wet particles of WP with water of 5 percent copper sulfate solution.

(2) Remove particles from flesh immediately.

(3) Do not use grease or ointment on WP burns. (Such use may result in poisoning).

(4) Wash affected area with soda solution, then with 5 percent copper sulfate solution.

WARNING

DO NOT WASH EYES WITH 5 PERCENT COPPER SULPHATE SOLUTION.

e. Wash eyes immediately with solution of 1 percent copper sulphate. If not available, wash eyes with large quantities of water for at least 15 minutes. Seek medical attention immediately.

f. When exposed to red phosphorus (RP) smoke, or hexachloroethane (HC) smoke or any riot control agent, the following precaution applies:

WARNING

- **RED PHOSPHORUS SMOKE, HC SMOKE OR ANY RIOT CONTROL AGENT MAY PRESENT AN INHALATION AND IRRITANT HAZARD. PROLONGED EXPOSURE OF THE EYES AND RESPIRATORY SYSTEM SHOULD BE AVOIDED.**
- **WEAR PROTECTIVE MASKS TO AVOID EXCESSIVE EXPOSURE.**

NOTE

- **Do not use smoke grenades in enclosed or confined areas.**
- **Smoke grenades produce heat and are a fire hazard.**

3-5. Maintenance Planning

a. *General*

(1) Proper performance of a maintenance operation depends primarily upon planning:

- (a) What is to be done?
- (b) How is the work to be done?
- (c) Who is to do the work?
- (d) Where is the work to be done?

(2) Before work on any item begins, each operation to be performed must be completely detailed. Tools, equipment, replacement parts, and supplies must be distributed and available at the points where they are to be used. Men experienced in the operation must be assigned to various phases of the job. Consideration must be given to conducting each operation so that maximum safety is afforded operator and equipment.

b. *Process Flow Charts.*

(1) A process flow chart (chart 3-1) serves as a guide for layout of the line. The chart records in proper sequence the operations found in an operating line. The flow chart lists the number of each operation, the personnel required, the tools to be used, and the materials needed. Materials include but are not limited to such items as new components, sealing, paint, etc.

(2) The chart picks up the ammunition to be processed and follows it through each operation until rework is completed. Operations include but are not limited to the following:

- (a) Unpacking.
- (b) Disassembly.
- (c) Replacing.
- (d) Repairing.
- (e) Reassembly.
- (f) Repacking.

Chart 3-1. Sample Process Flow Chart

No.	Operation	Primary	Secondary	Personnel required	Tools and equipment	Materials	Time required (min)
	Description						
1	Open boxes, remove fiber containers		X		2	Shears Pliers	2
2	Inspect boxes and containers		X		1		5
3	Strip tape from container, remove fuze, inspect		X		1		1

Each operation is listed as a main or secondary operation.

(3) A main line operation is essential to a smooth flow of production.

(4) Secondary operations may be shunted from the main line into branch lines to be returned at a point further along the main line.

c. *Standing Operating Procedure (SOP)*. A standing operating procedure must be prepared after the process flow chart is completed.

(1) *General*. The SOP (fig. 3-1) provides a detailed explanation of each operation, as follows:

(a) It expands on the information given on the flow sheet by explaining the mechanics of operation in detail.

(b) It lists additional information, such as special hazards, and special operating methods.

(c) It groups together the operations which will be performed in one unit of the line, operating room or one bay.

A. STANDING OPERATING PROCEDURE FOR: C&P Grenade Hand Frag Delay M61			
B. OPERATION NO. 3			
C. Bay No.			
D. SOP NO. AMXZZ-100		DATE 5 May 92	
E. Rev No. 1		DATE 10 Aug 92	
F Change No. 1		DATE 21 Aug 92	
G. OPERATION: PAINT GRENADE			
H. EXPLOSIVE LIMITS: UNITS: 60 EXPLOSIVE LBS: 21			
I. PERSONNEL LIMITS: OPERATORS: 1 TRANSIENTS: 1			
J.			
Step No.	Description		
1. Receive grenades from operation No. 2. 2. Fill paint container. 3. Dip grenade in paint. 4. Hang on rack until dry.			
Specific Instruction (Safety, Operational, Quality Characteristics.)			
1. (QC) Good workmanship-Visual* (DS-3) must be maintained. 2. (QC) Paint coverage must be adequate. *DS-3: The grenade will be free of dirt, chips, grease, rust and other foreign material.			
K. SPECIAL REQUIREMENTS Surveillance will perform periodic test to insure that all grounding is adequate.			
L. Equipment, tools, gages, and supplies.			
Item	Qty reqd	Spec No. or DWG NO.	NSN
Enamel	as req	MS 35527-8	8010-00-297-2116
Enamel		MS 35527-9	8010-00-297-2113
Enamel		TT-E-516	8010-00-848-9272
Dry rack	as req.	Fabricate	
Suspension device	as req	Fabricate	

Figure 3-1. Sample of standing operating procedure.

(2) *Instruction for preparation.* Prepare SOP's as follows:

Line A - Standing Operating Procedure For. Indicate operation and nomenclature of item being worked (e.g., "Care and Preservation Grenade, Hand: Fragmentation, Delay M61).

Line C - Bay NO. Show bay, room, or cubicle number.

Line G - Operation. Identify operation (e.g., paint grenade).

Line H - Explosive Limits. Specify maximum number of units and pounds of explosive within limitations established for area, consistent with safe and efficient operation.

Line I - Personnel Limits. Specify maximum number of operators and transients allowed at operation. (Transients may include on-post and off-post visitors, and trainees undergoing cross training.)

Line J - Step NO. Description-of Operation, and Specific Instructions. List procedural details of work to be performed under "Description" of operation in

numbered and logical sequence. Describe sufficiently to allow operator to accomplish task in safe and technically correct manner. Specific instructions are intended to furnish information that applies to one specific step of the operation not included in the actual description of physical work performed. (Items to be listed here include quality characteristics, specific safety equipment or clothing required, safety precautions to be taken, and technical instructions pertaining to task accomplishment.) Have all specific instructions indicate step and type of instruction: Safety (S), Operational (O) and Quality Control (QC). Locate specific instructions opposite step in operation description to which applicable.

Line K - Special Requirements. Include instructions which apply to one operation only and, normally, not to any other operation or particular step of operation. (Instructions may apply to safety, technical aspects of the operation, defect standards, or equipment inspection requirements. Items covered under item J of the SOP need not be duplicated under item K.)

3-6. Work Schedules

Operations for a specific task should be planned for completion on a day-to-day basis to eliminate the accumulation of hazardous material.

3-7. Line Layout

The line provided for these operations must permit safe and efficient flow of materials. [Where feasible, it will employ such items as roller conveyors, work tables, other tools, equipment (chap. 2) and expendable materials (see app. B)]. Personnel, work stations, type of equipment and material to accomplish the operations will be based on current work directives and results of preliminary inspection. Provisions shall be made, when necessary, to include barricades as required by section VIII, TM 9-1300-206. Figure 3-2 shows a typical line layout.

3-8. Lot Numbers

a. *General.* Lot numbering of ammunition serves to identify material.

(1) It assures accurate control of movements of items.

(2) It preserves and maintains surveillance records.

(3) It provides means of withdrawing defective, deteriorated, hazardous, or obsolete ammunition, and explosive material from service.

b. *Description and Use.* For all ammunitions, the lot number will normally consist of a manufacturer's identification symbol, and interfix number, and the serial number as illustrated:

ABC-8-124

(1) *Manufacturer's Identification Symbol.* The manufacturer's identification symbol will consist of one, two, or three letters. They are assigned to identify the arsenal, plant, depot or station, in case of loaded items, or indicate the contractor in case of components.

(2) *The Interfix Number.* Each lot number, including that of the first lot, will have an interfix number between the manufacturer's identification symbol and the serial number. The interfix number indicates the lots made according to a specific design or manufacturing procedure.

(3) *The Serial Number.* The serial number will identify the lot according to the sequence of production. Serial number will be changed with the information of each new group.

c. *Description and Use of Lot Numbers for Maintenance Operations.* For renovated, modified, or regrouped operations, the lotting will be accomplished as follows:

(1) *Maintenance.* Where new components replace like components (same model number), a lot suffix will be assigned by the Commander, US Army Armament Munitions and Chemical Command, ATTN: AMSMC-QAD, Rock Island, IL 61299-6000.

Example: US Army, Korea, Special Ammunition Depot 200 replaces fuzes. The suffix furnished for LOP 1-8 changed the lot number to LOP 18A.

(2) *Conversion/modification* Where components replace different components, components are added or where work is extensive enough to warrant model number change (e.g., from Grenade, Hand, Fragmentation M26 to M26A1) new lots will be formed. Lot numbers will be assigned in the

normal manner, except that the interfix number will start with 500 instead of 1 and the manufacturer's symbol will be that of the facility performing the work

(3) *Regrouping.* Regrouping or mixing of grenade ammunition lots will be permitted only when grenades are assembled with new fuzes from the same fuze lot. AMSMC-QAD will assign an identification symbol for relotting when required.

3-9. Ammunition Data Card (DD Form 1650)

a. *General.* An Ammunition Data Card (DD Form 1650) (fig. 3-3) is a historical record of all required data pertaining to each lot of the item. Data cards will be prepared when relotting grenades or whenever a suffix is assigned to the existing lot number. Data cards will be distributed as follows:

- (1) Commander
US Army Armament, Munitions and
Chemical Command
ATTN: AMSMC-QAD
Rock Island, IL 61299-6000
2 copies

(2) Recipient of the ammunition (other depot, ASP, etc.)-2 copies

b. *Reproduction and Format.* Copies of original data cards, if not locally available, may be requested from Commander, US Army Armament, Munitions and Chemical Command, ATTN: AMSMC-QAD, Rock Island, IL 61299-6000. Data cards will be 5 x 8 inches in size and printed on commercial manila tag board (or equal), and of approximately 200 pounds ream weight. Local reproduction of the blank form is authorized. Data cards may be hand printed or reproduced by mimeograph, offset printing, and individual typing, provided the product results in a clean, black image that lends itself to 35mm microfilm reduction.

c. *Required Information.* Complete Ammunition Data Card in accordance with following instructions:

(1) Maintenance.

(a) *Blocks 1 through 26, as applicable, except 2-5, 8-9, 11-13, 23-23a and 26.* Transcribe information contained in basic data card to new card.

(b) *Block 2.* Change NSN, depending on type of package used.

(c) *Block 3.* Insert complete lot number of item represented by data card. Indicate reworked lot by using applicable alphabetical suffix specified in authorization document for removal of item.

(d) *Block 4.* Change activity, depending agency performing renovation.

(e) *Block 5.* Change quantity, depending on number of rejects generated and quantity used.

(f) *Block 8.* Indicate PRON on work order number.

(g) *Block 9.* Reflect latest drawing number.

(h) *Blocks 11-13.* Change start, completion, and inspection dates.

(i) *Block 23.* For loaded items, furnish information for each component part (e.g., subassembly, explosive, propellant, or other material used in assembly of loaded item described by data card). For inert items manufactured by more than one manufacturer, compile data as follows:

1. *Component.* Give approved item name.

2. *Drawing Number.* Enter drawing number, revision letter and applied E.O.'s, if any.

3. *Model.* Enter model number for any item or subassembly to which model number has been assigned.

4. *Manufacturer.* Give name of manufacturer of each lot of each component used. If any parts are furnished by supplier not identified in block 7, furnish complete information required for loaded item description (i.e., identity of supplier, date manufacture, lot number, and quantity).

5. *Date Manufactured.* Enter month and year (if available) during which each lot of each component was made.

6. *Lot Number.* Enter complete lot number of each component used in loading item.

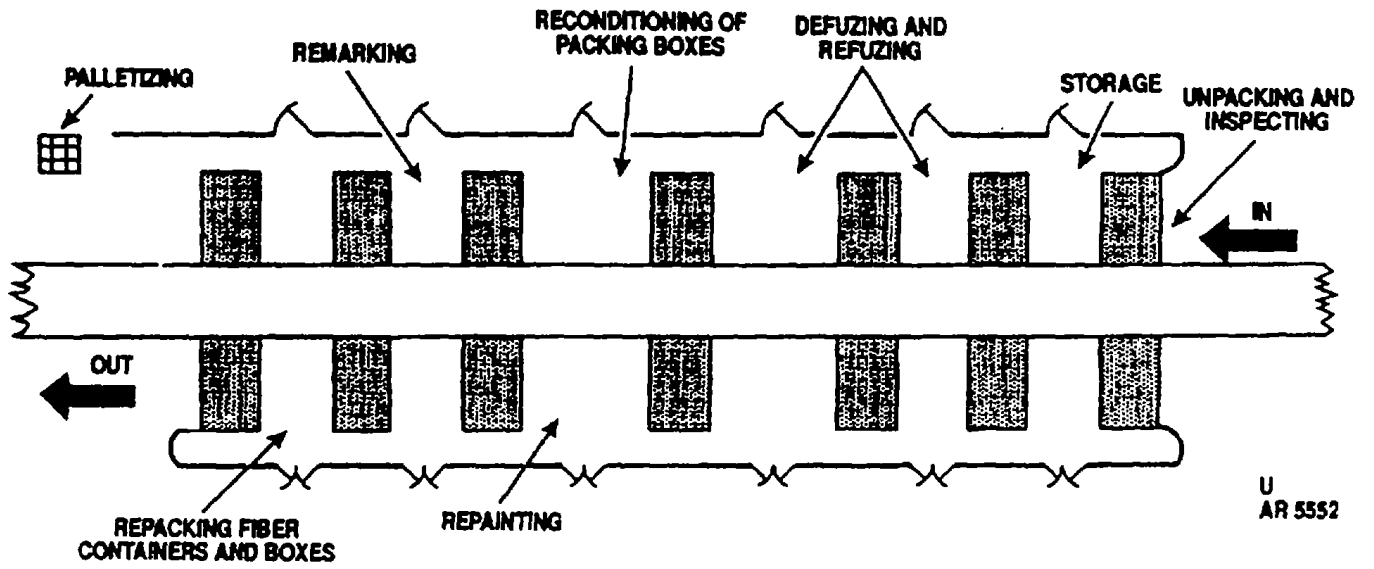

Figure 3-2. Typical line layout.

7. *Quantity*. When more than one lot of same component is used in assembly of a loaded item, indicate in column five quantity from each lot, within five percent. Do not make entry when all components of each type are from same lot. If inert items are manufactured by single manufacturer, compile data applicable to information contained in 2, 3, and 7 above.

(j) *Block 23a*. This is a continuation of block 23. Use when required. If additional space is needed beyond that provided, extend list of components into Remarks section.

(k) *Block 26*. Include following information under Other Remarks.

1. Description of any unusual or important methods of inspection.

2. Description of method or rework or renovation used to rework rejected or unserviceable lots.

(2) *Conversion/Maintenance and Regrouping*.

(a) *Blocks 6, 9, 10, 15, 17 through 19*. Transcribe information contained in basic card to new card.

(b) *Remaining blocks*. Compile required data specifically affecting maintenance operation being performed. Regarding item 23, when regrouping, list lot numbers grouped (regrouped) to form new lot.

DEPARTMENT OF DEFENSE AMMUNITION DATA CARD				Form Approved Budget Bureau No. 22-RO269		
1. ITEM NOMENCLATURE 34594 Grenade, Hand OFFensive, M03A2 W/Fuze		2. PN 1330-143-6807-G911		3. LOT NUMBER IOP-22-88		
4. MANUFACTURING, LOADING OR ASSEMBLY ACTIVITY IOWA ARMY AMMUNITION PLANT BURLINGTON, IOWA		8. NET QUANTITY 67,080		6. PACKING OF LOT See Remark #1		
7. CONTRACTOR MASON & HANGER, ELIAS MASON CO., INC.	5. CONTRACT OR ORDER NO. 3720-A1-0-A0101	9. DRAWING OR REVISION 9215458-D	10. SPECIFICATION, DESIGNATION RIL-G-13708C(RU) W/EO 55924-2			
11. DATE STARTED 17 November 1970	12. DATE COMPLETED 25 November 1970	13. DATE INSPECTED 25 November 1970	14. LINE SA	15. TYPE OF SHELL		
14. CHARGE WEIGHT	16. INDEX OF POWDER	17. WPD IN INCHES	18. PPD IN INCHES			
19. EXPLOSIVE WEIGHT PER POUND	20. EXPECTED MUZZLE VELOCITY	21. EXPECTED PRESSURE	22. SHELL WEIGHT			
23. NUMBER OF TEST SAMPLES 50	24. SENT TO	25. DATE AND MODE OF IMPMENT				
18. COMPONENTS (Continue on reverse, if necessary) Card of 1						
COMPONENT NAME	DRAWING NO.	MODEL	MANUFACTURER	DATE WPD.	LOT NO.	QUANTITY
Body Ass'y	9215464-D		Ametek Plymouth	1970	FYI-1-20	55,650
Pad, Felt	9215463-B		Commonwealth Felt	1970	FYI-1-23	11,480
Liner, Fuzewell	9215461-B		Riverside Prod.	1970	CPC-1-5 RPD-1-8	
26. DISPOSITION ACCEPTED			27. TYPED NAME OF GOVERNMENT INSPECTOR Clifford McKenzie			SIGNATURE <i>Clifford McKenzie</i>

DD FORM 1650 (1 FEB 68) (FRONT)

COMPONENTS (Continued)				IOP-22-88		
COMPONENT NAME	DRAWING NO.	MODEL	MANUFACTURER	DATE WPD.	LOT NO.	QUANTITY
Charge, TNT	7548643-L	GR-1	Volunteer A.A.P.	1970	VOL-8-599 VOL-8-600	1,200# 32,365#
Barium Stearate	MIL-B-366		Witco Chemical	1969	None	
Graphite	MIL-G-155-A		Superior Graphite	1969	None	
Fuze, Grenade, Hand	7548570-M	M206A2	Ordnance Prod.	1970	OPI-7-16	
Sleeve, Fiberglass	9212255-B		Volutube Corp.	1970	VOL-8-3	
Container, Fiber	9211614-A		Platt Corp.	1970	PLC-1-19	
Support, Plastic	9211614-A		Bolland Plastic	1970	None	
Box, Wood Packing	9211615-A		Bennett Box Co.	1970	None	
28. REMARKS (Identify by appropriate symbols: *Changes in process; **Deviation from drawing or specification; ***Unusual occurrence or condition).						
Remark #1 1 Grenade/Fiber Container (Double Foil), 20 Containers/Wood Box (Treated), 45 Boxes/Pallet (Treated), MIL-P-15011-P. (Avg. Wt. of Pallet is 1,766 lbs.) ** 100% X-ray of Fuzes prior to loading per 1050 MSG. No. AEP-W-25-69 dated 27 August 1969, signed Guenzler.						

DD FORM 1650 (1 FEB 68) (BACK)

90

U
AR 6057

Figure 3-3. Ammunition data card (DD Form 1650).

THIS PAGE INTENTIONALLY LEFT BLANK

CHAPTER 4 INSPECTION REQUIREMENTS

4.1 General

Items received at direct and general support levels will be inspected on a lot sampling basis. The purpose of this inspection is to determine quality of the material and need for repair and/or renovation. One hundred percent inspection may be required to remove unserviceable items from the stockpile.

4.2 Sample Selection

a. The inspector will evaluate the storage condition prior to sample selection. The storage history of the sample should be similar to that of the lot. The sample should include conditions representative of the entire lot and in the approximate percentages in which the conditions occur. Each carton and box from which samples are selected will be identified. Identity will be maintained as long as the lot remains at the storage location.

b. Samples from each inspection lot will be selected as follows:

- (1) Thirty hand grenades, no more than two from the same wooden box.
- (2) Thirty rifle grenades, no more than two from the same wooden box.
- (3) Fifty hand grenade fuzes, no more than ten from the same wooden box.

NOTE

Rifle grenade cartridges packed with rifle grenades will be inspected under the same sample size as rifle grenades.

- (4) Thirty launcher grenades, smoke screening, (L8A1, L8A3, M76, M82, M90), riot control (L96A1, L97A1), and non-lethal (M98 and M99), no more than one from the same metal box.

4.3 Visual Inspection

(a) *Shipping container.* Record on DA Form 984-R (Munitions Surveillance Report) all pertinent information for lot identification, manufacturer, date, etc.

- (1) Inspect exterior of each container and record on DA Form 984-R (Munitions Surveillance Report) evidence of water damage or other defects.
- (2) Remove grenades from their containers and number serially; record number on DA Form 984-R (Munitions Surveillance Report).
- (3) Inspect interior of each container and record any damage on DA Form 984-R (Munitions Surveillance Report).

(b) *Grenades.* Record on DA Form 984-R (Munitions Surveillance Report) all pertinent information on grenades, lot identification, manufacturer, date, fuze lot, etc. Inspect grenades and classify defects in accordance with paragraph 4-6.

4.4 Evaluation of Grenade Defects

Evaluating acceptability of material exhibiting deterioration or damage defects is a judgment type decision. The following guidelines will be used in establishing a uniform system for examination for deterioration or damage and to make the inspection report meaningful.

(a) *First Stage (Incidental Deterioration).* Incidental deterioration has no effect upon usability. The product is acceptable for issue and does not require reconditioning at the time of inspection.

(b) *Second Stage (Minor Deterioration).* Minor deterioration does not significantly reduce functionality. However, care and preservation are required to restore the appearance of the material prior to issue for basic load retention in long-time storage.

(c) *Third Stage (Major Deterioration).* Major deterioration significantly reduces or precludes usability of the item or packing material. Such deterioration normally calls for replacing the item or component by maintenance-type operations prior to issue.

(d) *Fourth Stage (Critical Deterioration).* Critical deterioration is so extensive that it creates a hazardous condition for persons using or maintaining the material.

4.5 Evaluation of Packing Material Defects

Packing material will be evaluated in accordance with tables 4-1 through 4-3.

Table 4-1. Wooden Boxes and Crates.

	Reparable	Irreparable
A. Hardware Must be operative and tight.	A. Hardware Repair or replace.	A. Hardware N/A
B. Ends No damaging defects.	B. Ends Replace during repair.	B. Ends N/A
C. Wood	C. Wood	C. Wood
1. Splits less than 3 inches long, if not closer than 1 inch to edge of board or to adjoining split, and if each piece is secured by at least one nail when split terminates at end of board.	1. Repair splits over 3 inches long by using corrugated fasteners; otherwise, replace board(s).	1. N/A
2. Cracks, 1/4-inch wide or less, between boards.	2. If cracks are more than 1/4-inch wide, replace board.	2. N/A
3. Warp allowed, if it does not prevent sealing of box or prevent insertion or required ammunition.	3. If warps prevent insertion or removal of grenades or prevent sealing of the box, replace boards.	3. N/A
4. Light mold which can be brushed off is acceptable. Mildew stains are permitted, if they do not prevent ready identification of markings.	4. Dry out or replace wet boxes.	4. N/A
5. Breaks in body.	5. Replace broken board(s).	5. N/A
6. Nails, screws and fasteners must all be present and in good condition.	6. Replace and/or properly seal imperfect nails, screws, and fasteners.	6. N/A
7. Sound, tight knots allowed, if the dimension measured across board is not greater than 1/4 the width of the skid.	7. Replace board(s) with knots more than 1-1/2 inch in largest diameter, if the diameter is less than 1/3 the width of the board.	7. N/A
8. Skids securely attached to box or crate. Knots not greater than 1/4 the width of the skid.	8. Replace or repair defective skids.	8. N/A
D. Strapping and banding All present and not weakened by rust or distortion.	D. Strapping Replace where required.	D. Strapping N/A

Table 4-2. Fiber Containers

	Reparable	Irreparable
<p>A. Metal ends Must be free from rust, cracks, indentations or splits which would impair waterproofing serviceability of fiber container.</p> <p>B. Body and cap 1. No tears, cuts or gouges.</p> <p>2. No mold, mildew or rot.</p> <p>3. No wrinkles caused by looseness between layers.</p> <p>4. Blisters with area totaling less than 1/2 square inch.</p> <p>5. Slight discoloration, if container is still considered waterproof.</p> <p>6. No loose or missing neck rings.</p>	<p>A. Metal ends Derust and repaint.</p> <p>B. Body and cap 1. Spot paint, with acid-proof, black paint, cuts tears or gouges not closer than 1 inch to closure, less than 1/2 inch in area, and not through impregnated layers.</p> <p>2. Repair not feasible.</p> <p>3. Repair and repaint w/ acid-proof, black paint.</p> <p>4. Repaint with acid-proof, black paint.</p> <p>5. Repaint with acid-proof, black paint.</p> <p>6. N/A</p>	<p>A. Metal ends Any perforations, excessive rust or ends which are crushed or not securely crimped to body.</p> <p>B. Body and cap 1. Cuts, tears or gouges closer than 1 inch to closure, more than 1/2 inch in area, or through all impregnated layers.</p> <p>2. All mold, mildew or rot.</p> <p>3. N/A</p> <p>4. N/A</p> <p>5. N/A</p> <p>6. Loose or missing rings.</p>

Table 4-3. Metal Containers

	Body	Body
1. Seams must be tight to prevent entrance of moisture.	1. Repair not feasible.	1. Remove grenade, repack in fiber container.
2. Rust-none.	2. Rust-derust and repaint.	2. Rust which has caused pitting and perforations.
3. Perforations-none.	3. Repair not practical.	3. Perforations.

4-6. Classification of Defects

Grenades, components and packing material defects are outlined below.

a. *Rifle Grenades.*

- (1) *Critical Defects.*

(a) Safety pins missing, broken or unsecurely assembled to the extent that they endanger user.

(b) Markings misleading as to type of grenade.

(c) Grenades mixed within the lot which can result in hazardous or unsafe conditions for persons using or maintaining the items.

(d) Propellant spills out of grenade cartridge to the extent that grenade cartridge is unsafe for use.

(e) Grenades show signs of filler leakage.

(f) Markings misleading as to color of smoke.

(2) *Major Defects.*

(a) Damage to the grenade which can materially reduce usability of the item or result in failure.

(b) Rust or corrosion to the extent that the grenade cannot be used as intended.

(c) Grenades loose in containers to the extent items cannot be adequately protected in transit.

(d) Safety devices damaged to an extent which would preclude use of the grenade as intended.

(e) Lot number missing or illegible.

(f) Grenade cannot be removed from container.

(g) Rifle grenade cartridge missing.

(h) Head, stabilizer tube, fin assembly or any other component loose or damaged to the extent that use of grenade is precluded.

(i) Air hole missing on nose end of grenades M22 Series and M23 Series.

(j) Nose plug missing from Grenades M22 Series.

(3) *Minor Defects.*

(a) Slight scratches attributable to normal handling or shipping (b) Paint defects (e.g., scale, peeling, blistering etc.)

(c) Layers of flaked rust which, when removed, leave pitting that will not affect function. Care and preservation are required, however, to return items to serviceability.

(d) Etching of metal with marked evidence of penetration (but not affecting functioning). Reconditioning is required to return items to serviceability.

(e) Marking of grenade is incomplete or illegible, but type of grenade and lot number are identifiable.

(f) Tape missing over smoke port holes of Grenades M22 Series and M23 Series.

(g) Inadequate paint coverage.

b. *HE Hand Grenades.*

(1) *Critical defects.*

(a) Safety pins missing, broken or unsecurely assembled to the extent that they endanger user.

(b) Safety clip, where applicable, missing or improperly positioned.

(c) Either or both lever hinge ears missing.

(d) Both lever hinge ears not bent away from the body past the vertical center line of the body hinge bosses.

(e) Ends of both lever hinge ears not bent upwards.

(f) Markings misleading as to type of grenade.

(g) Grenades mixed within the lot which can result in hazardous or unsafe conditions for persons using or maintaining the items.

(h) Grenade packed upside down in fiber or metal container.

(2) *Major Defects.*

(a) Damage to the grenade which can materially reduce usability of the item or result in failure.

(b) Rust or corrosion to the extent that the grenade cannot be used as intended.

(c) Grenades loose in containers to the extent items cannot be adequately protected in transit.

(d) Safety devices damaged to an extent which would preclude use of the grenade as intended.

(e) Lot number missing or illegible.

(f) Any of the following missing, or damaged to an extent which would preclude use of the grenade: pull ring, safety lever, and/or fuze.

(g) Improperly assembled, or seated fuze, or loose fuze.

(h) Either lever hinge ear not bent away from the body past the vertical center line of the body hinge boss.

(i) End of either lever hinge ear not bent upwards.

(3) *Minor Defects.*

(a) Slight scratches attributable to normal handling or shipping.

(b) Paint defects (e.g., scale peeling, blistering etc.) (c) Layers of flaked rust which, when removed leave pitting that will not affect functioning. Reconditioning is required, however, to return items to serviceable condition.

(d) Marking of grenade is incomplete or illegible, but type of grenade and lot number are identifiable.

(e) Inadequate paint coverage.

(f) Etching of metal with marked evidence of penetration (but not affecting functioning). Reconditioning is required to return items to serviceability.

c. *Chemical Hand Grenades*

(1) *Critical Defects.*

(a) Safety pins missing, broken or insecurely assembled to the extent that they endanger user.

(b) Markings misleading as to type of grenade.

(c) Grenades mixed within the lot which can result in hazardous or unsafe conditions for persons using or maintaining the items.

(d) Grenades show signs of filler leakage.

(e) Marking misleading as to color smoke.

(f) Grenade packed upside down in fiber or metal container.

(2) *Major Defects.*

(a) Damage to the grenade which can materially reduce usability of the item or result in failure.

(b) Rust or corrosion to the extent that the grenade cannot be used as intended.

(c) Grenades loose in containers to the extent items cannot be adequately protected in transit.

(d) Safety devices damaged to an extent which would preclude use of the grenade as intended.

(e) Lot number missing or illegible.

(f) Grenade cannot be removed from container.

(3) *Minor Defects.*

(a) Slight scratches attributable to normal handling or shipping.

(b) Paint defects (e.g., scale, peeling, blistering etc.).

(c) Layers of flaked rust which, when removed, leave pitting that will not affect functioning. Reconditioning is required, however, to return items to serviceability.

(d) Marking of grenade is incomplete or illegible, but type of grenade and lot number are identifiable.

(e) Inadequate paint coverage.
 (f) Etching of metal with marked evidence of penetration not affecting functioning. Reconditioning is required, however, to return items to serviceability.

d. *Hand Grenade Fuze Defects.*

(1) *Critical Defects.*

(a) Safety pin, pull ring assembly improperly assembled. Safety pin must extend through fuze body and prongs must be spread sufficiently to prevent accidental withdrawal.

(b) Safety clip, where applicable, missing or improperly positioned.

(c) Either or both lever hinge ears missing.

(d) Both lever hinge ears not bent away from the body past the vertical center line of the body hinge bosses.

(e) Ends of both lever hinge ears not bent upwards.

(f) Striker hinge pin missing or not positioned in both holes at opposite sides of fuze body.

(g) Loose or caked powder on outside wall of detonator case.

(h) Data stamping missing, incorrect or illegible.

(i) Other damage not listed above that is capable of affecting safe handling, assembly or proper functioning of fuze.

(2) *Major Defects*

(a) Lugs missing or damaged.

(b) Detonator case damaged or loose.

(c) Either lever hinge ear not bent away from the body past the vertical center line of the body hinge boss.

(d) End of either lever hinge ear not bent upwards.

(3) *Minor Defect.* Painting inadequate.

e. *Packaging.*

(1) *Critical Defects.* None.

(2) *Major Defects.*

(a) Weathering or dry-rotting of boxes to the extent contents are not adequately protected and require replacement, or damage to the extent contents cannot be readily removed.

(b) Looseness of container cap or closure to the extent that contents cannot be adequately protected.

(c) Missing, broken or ineffective hardware, packing component or banding.

(d) Contents loose to the extent item cannot be adequately protected in transit.

(3) *Minor Defects.*

(a) Wetness, moldiness or mildew of inner containers (except metal).

(b) Missing or broken handle or cleat.

(c) No contact between inner layer of sealing tape and surface of the container for at least 1/2 inch (for 1 1/2-inch tape); 1/4 inch (for 1 inch tape or under) on each side of the joint around the entire circumference.

f. Smoke Screening Grenades, RP L8A1, L8A3. The L8A1 and L8A3 grenades are used with M239 and similar grenade launchers. Refer to appropriate vehicle operator's manual for additional data.

(1) *Critical Defects.*

(a) Markings misleading as to type of grenade.

(b) Grenades show signs of filler leakage.

(2) *Major Defects.*

(a) Metal base punctured.

(b) Rubber body torn or dry rotted.

- (c) Electrical contracts corroded or bent.
- (d) Metal foil covering gas propulsion hole, missing or punctured.

(e) Grenade distortion preventing insertion into launcher (discharger).

(f) Markings are illegible.

(3) Minor Defects

(a) Slight scratches attributable to normal handling or shipping.

(b) Paint defects (e.g., rust scale, peeling, blistering etc.)

(c) Inadequate paint coverage.

g. 66mm Anti-Riot Grenades (L96A1 and its trainer, L97A1) are used with 66mm dischargers, primarily the M7. Refer to operator manuals for the Light Vehicle Obscuration Smoke System (TM 3-1040-286-12&P) and the installation Kit, Grenade Launcher, Adjustable Multi-purpose, 66mm, Turret Mount, XM315 (TM 3-1055-649-12&P).

(1) Critical Defects

(a) Markings misleading as to the type of grenade.

(b) Grenades show signs of filler leakage.

(2) Major Defects

(a) Electrical clips are bent or corroded.

(b) Rubber body is torn or dry rotted.

(c) Grenade distorted preventing insertion into the discharger.

(d) Markings are illegible.

h. 66mm Non-Lethal Grenades (M98 Distraction and M99 Blunt Trauma) are used with 66mm dischargers, primarily the M7. Refer to operator manuals for the Light Vehicle Obscuration Smoke System (TM 3-1040-286-12&P) and the Installation Kit, Grenade Launcher, Adjustable Multi-purpose, 66mm, Turret Mount, M315 (TM 3-1055-649-12&P).

(1) Critical Defects

Markings misleading as to the type of grenade.

(2) Major Defects

(a) Electrical clips are bent or corroded.

(b) Metal body is dented or end cap is loose.

(c) Markings are illegible.

4-7. Disposition of Inspected Lots

A lot of hand, rifle grenades and/or hand grenade fuzes will be inspected and screened 100 percent if one critical defect is observed. Disposition of inspected lots will be in accordance with tables 4-4 and 4-5.

a. A lot of hand, rifle-grenades and/or hand grenade fuzes will be acceptable for issue and use if the criteria indicated in table 4-4 are met.

Table 4-4. Lots Released for Issue and Use

Item	Sample Size	Defects			
		Major		Minor	
		Accept #	Reject #	Accept #	Reject #
Grenades	30	1	2	2	3
Hand Grenade Fuzes	50	2	3	4	5

b. A lot of hand, rifle-grenades and/or hand grenade fuzes will be acceptable with priority of issue if

the criteria indicated in table 4-5 are met.

Table 4-5. Lots Released for Priority of Issue

Item	Sample Size	Defects			
		Major		Minor	
		Accept #	Reject #	Accept #	Reject #
Grenades	30	4	5	6	7
Hand Grenade Fuzes	50	7	8	10	11

NOTE

Any lot hand, rifle grenades and/or hand grenade fuzes not meeting the conditions stated in table 4-4 and 4-5 shall be inspected 100 percent and reworked as required. Any lot L&A1 grenades not meeting the conditions stated in tables

4-4 and 4-5 shall be inspected 100%. Serviceable items shall be acceptable for issue; unserviceable items shall be forwarded to disposal personnel for their disposition. Prior to release of any lot, the packaging shall meet the requirements covered in paragraph 4-5.

CHAPTER 5 MAINTENANCE PROCEDURES

5-1. General

Operations to be performed are not restricted to those outlined below. The number of operations depends on the degree and/or type of maintenance being performed. Refer to Maintenance Allocation Chart (MAC) in TM 9-1330-200-12 for levels of maintenance to be performed. Since ammunition has a long shelf life, some very old items may occasionally be encountered. Ammunition color coding is now in its third generation. The three generations of color coding are illustrated in Table 1-2, pages 1-6 through 1-10 in TM 9-1300-200, Change 3. Ammunition manufactured prior to 1962 was generally painted as shown for the first generation color code. The second generation coding was used between 1962 and approximately 1976 when the third generation code came into use. The policy used in this matter is that grenades are not reworked solely to change colors or update color code. If grenades are reworked for any other reason, repainting to later color code may be performed if authorized by maintenance directors.

5-2. Maintenance Operational Procedures

The following maintenance operational procedures are listed sequentially. They serve as a guide for establishing maintenance plans.

a. *Rust Removal and Touch Up.*

- (1) Receive grenades from unpacking or inspecting operation.
- (2) Using cloth wet with solvent, remove all traces of minor rust and defective markings.
- (3) Use abrasive material or nonferrous wire brush to remove other than minor rust from grenade.

- (4) Using paint brush and required enamel, touch up unpainted surfaces of grenade where original coating has been damaged. For paint colors, see tables 5-1 through 5-10.

- (5) Following touch up, place grenade in safe location in work area until enamel has dried, then transfer to next operation.

- (6) Transfer grenades requiring complete repainting after removing rust or defective markings to repainting operations.

- (7) Materials, tools, and equipment include the following:

- (a) Enamel.
- (b) Solvent.
- (c) Rags.
- (d) Brush, paint.
- (e) Table, work.
- (f) Can, plunger-safety type.
- (g) Gloves, disposable.
- (h) Brush, wire.

- b. *Repainting Grenades.* For color used to repaint grenade bodies, see tables 5-1 through 5-10.

Table 5-1. Painting and Marking of Hand Grenade Bodies

Grenade	Body color	Color of markings	Height of letters (in.)	Marking
Fragmentation M26	(1)	(2)	1/4	GRENADE HAND FRAG M26 MO.-YR. COMP B LOT NUMBER
M26A1	(1)	(2)	1/4	GREANDE HAND FRAG M26A1 MO.-YR. COMP B LOT NUMBER
M26A2	(1)	(2)	1/4	GRENADE HAND FRAG M26A2 NO.-YR. COMP B LOT NUMBER
M33	(1)	(2)	1/8	GRENADE HAND FRAG DELAY M33 NO.-YR. COMP B LOT NUMBER
M57	(1)	(2)	1/4	GRENADE HAND FRAG IMPACT WITH- DELAY OVERRIDE M57 MO.-YR. COMP B LOT NUMBER
M59	(1)	(2)	1/8	GRENADE HAND FRAG IMPACT M59 MO.-YR. COMP B LOT NUMBER
M61	(1)	(2)	1/4	GRENADE HAND FRAG IMPACT M61 MO.-YR. COMP B LOT NUMBER
M67	(1)	(2)	1/8	GRENADE HAND FRAG DELAY M67 MO.- YR. COMP B LOT NUMBER
M68	(1)	(2)	1/8	GRENADE HAND FRAG IMPACT M68 MO.-YR. COMP B LOT NUMBER
Mk2	(1)	(2)	1/8 to 1/4	STRIPE AROUND BODY NEXT TO FUZE SEAT
Offensive MK3A2	(5)	(2)	1/4	GRENADE HAND OFFENSIVE MK3A2 LOT NUMBER TNT MO.-YR.
Chemical MK1, illumination M7, riot	(3)(4) (band only) (6)	(5) (7)	1/4 1/2	HAND ILLUMINATING GRENADE MK1 LOT NUMBER GAS CN RED BAND LOT NO. CN
M7A1, riot	(6)	(7)	1/2	RED BAND LOT NO.
M7A2, riot	(6)	(7)	1/2	ABC-M7A2 RIOT CS RED BAND LOT NO.

See footnotes at end of table.

Table 5-1. Painting and Marking of Hand Grenade Bodies - Continued

Grenade	Body color	Color of markings	Height of letters (in.)	Marking
M7A3, riot	(6)	(7)	1/2	M7A3 RIOT CS RED BAND LOT NO.
M8 HC	(9)	(5)	1/2	AN-M8 SMOKE HC LOT NO.
M14, TH3	(7)	(5)	1/2	AN-M14 INCEN TH3 LOT NO.
M15, WP	(6)	(2)	1/4; 1/2 (band)	SMOKE WP BURSTING TYPE YELLOW BAND LOADERS ID MO.-YR. LOT NO.
M18, smoke	(9); (1) (top of grenade corresponds with color of smoke)	(5)	1/2; 1/4 (lot no.)	M18 SMOKE RED OR GREEN YELLOW, VIOLET LOT NO.
M25A1, riot	(6)	(7)	1/2 (red letters and band); 1/8 (yellow band)	RIOT RED CN RED M25A1 RED (Place this information on single line around grenade body.) YELLOW BAND
M25A2, riot	(6)	(7)	1/2 (red) 1/8 (yellow band)	RIOT RED CS-1 RED ABC-M25A2 RED LOT NO. RED (Place this information on single line around grenade body.) YELLOW BAND
M34, WP	(9)	⁷ (lettering) ² (band)	1/2; 1/4 (date, lot no., and band)	M34 FRONT SIDE WP SMOKE MO.-YR. REVERSE SIDE LOT NO. YELLOW BAND
M47, riot, CS	(6)	(7)	3/8 (red lettering); 1/2 (red band)	GRENADE RED RIOT RED CS RED M47 (Place this information on single line around grenade body.) LOT NO.

See footnotes at end of table.

Table 5-1. Painting and Marking of Hand Grenade Bodies-Continued

Grenade	Body color	Color of markings	Height of letters (in.)	Marking
M48, smoke, colored	(9)	(5)	5/8 (black band); 3/8 (black lettering)	GRENADE BLACK SMOKE RS M48 (Place this information on single line around grenade body.) LOT NO.
M54, riot	(6)	(7)	1/2	M54 RIOT CS RED BAND LOT NO.
M58, riot	(6)	(7)	1/4 (band also); 1/8 (lot no.)	M58 GRENADE CS POCKET LOT NO. RED BAND
M30, Practice	(10); (11) (neck)	(4)	1/4	GRENADE HAND PRACTICE M30 MO.-YR. LOT NO. BROWN BAND
M62	(10); (11) (neck)	(4)	1/4	GRENADE HAND PRACTICE DELAY M62 MO.-YR. LOT NO. BROWN BAND
M69	(10); (11) (neck)	(4)	1/8	NSN 1330-178-8515 GRENADE HAND PRACTICE BROWN BAND
M83	(12)	(9)	1/2	FOREST GREEN MARKINGS, WITH BLUE BAND AND WHITE TOP
M84	(1)	(4) (4) (13) (11)	1/8 1/8 (lot no.) 0.7 (band) 1.0 (band)	GRENADE STUN M84 LOT NO. PASTEL GREEN BAND AROUND MIDDLE OF BODY BROWN BAND AT TIP END OF FUZE SAFETY LEVER
M102	(10)	(4)	1/4	MODEL M102 LOT NO. BROWN BAND AT TIP END OF FUZE SAFETY LEVER

¹ Olive Drab No. 34087 or 34127

² Yellow No. 33538

³ Unpainted

⁴ White No. 37875

⁵ Black No. 37038

⁶ Gray No. 36231

⁷ Red No. 31158

⁹ Light Green No. 34558

¹⁰ Blue No. 35109

¹¹ Brown No. 30117

¹² Forest Green No. 34079 or 35083

¹³ Pastel Green No. 34540

Table 5-2. Marking of Rifle Grenade Bodies

Grenade	Body color	Color of markings	Height of letters (in.)	Marking
M31, HEAT	Black No. 37038	Yellow No. 33538	1/4 for all markings, except 1/8 for Lot No. and date	GRENADE RIFLE HEAT M31 LOT NUMBER MO.-YR.
M191A1 WP	Light Green No. 34558	Red No. 31136 (lettering) Yellow No. 33538 (Band)	1/4 for grenade and Lot No.; 1/2 for M19A1 and WP	GRENADE M191A1 WP LOT NO. MO.-YR.
M22 - M22A2 Smoke	Green No. 34558 (body); Green No. 34108, Yellow No. 33538, Red No. 31136, corresponding color smoke (body union)	Black No. 37038	1/2 for nomenclature and color smoke; 1/4 for Lot No. and date	GRENADE M22A2 (or M22) SMOKE (OR YELLOW, GREEN) LOT LUMBER MO.-YR.
M23 - M23A1 Streamer	Same as for M22-M22A2	Black No. 37038	Same as M22-M22A2	GRENADE RIFLE M23A1 (OR M23) RED STREAMER (OR YELLOW, GREEN) LOT NUMBER MO.-YR.
M29, Practice	Blue No. 35109	White no. 37875	1/2 for nomenclature; 1/4 for Lot No. and date	GRENADE RIFLE PRACTICE, M29 LOT NUMBER MO.-YR.
M100, Entry Munition	Black/Brown No. 30117	Yellow	5mm all markings	GRENADE, RIFLE ENTRY MUNITION
M101, Entry Munition, Trainer	Black/Blue No. 35109	Brown	5mm all markings	GRENADE, RIFLE ENTRY MUNITION, TRAINING, PRACTICE

Table 5-3. Painting and Marking of RP Smoke Screening Grenades

Grenade	Body color	Color of markings	Height of letters (in.)	Marking
L8A1	Light green	Brown	5/16	GREN DSCHGR SMK SCR L8A1
			1/2	VM
			1/4	LOT NO. MFG CODE MO.-YR.
L8A3	Light green	Brown	5/16	GREN DSCHGR SMK SCR L8A3
			1/2	VM
			1/4	LOT NO. MFG CODE MO.-YR.

Table 5-4. Painting and Marking of IR Smoke Screening Grenades.

Grenade	Body color	Color of markings	Height of letters (in.)	Marking
M76	Light green	Black No 37038	5/16	GREN LCHR SMK IR SCREENING M76
		Black No. 37038	3/16	LOT NO.
		Yellow No. 33538	5/16	YELLOW BAND

Table 5-5. Painting and Marking of Simulant Screening Smoke Grenades

Grenade	Base color	Color of markings	Height of letters (in.)	Marking
M82	Light Green	Black No. 37038	0.25	GREN LCHR SMK; SIMULANT SCRN M82
		Black No. 37038	0.19	LOT NO.
		Blue No. 35109	0.50	BLUE BANDS
		Yellow No. 33538	0.25	YELLOW BAND

Table 5-6. Painting and Marking of Screening TA M90 Grenades.

Grenade	Base color	Color of markings	Height of letters (in.)	Marking
M90	Top-half black Bottom-half Light Green	Black No 37038	.25	GREN LCHR SMK SCREENING TA M90
		Black No. 37038	.25	LOT NO.
		Brown No. 30117 or 30140	.31	Brown Band

Table 5-7. Painting and Marking of Grenade, Discharger, Anti-Riot, Irritant, CS, L96A1.

Grenade	Body color	Color of markings	Height of letters (in.)	Marking
L96A1	Light Gray to BS381C No. 631	White	8mm (0.315 in)	GREN DSCHGR A/Riot IRRT CS L96A1
		Post Office Red, BS381C No. 538	5mm (0.200 in)	Red Band
		Middle Brown BS381C No. 411	5mm (0.200 in)	Brown Band
		White	6mm (0.236)	CS
		White	6mm (0.236 in)	Initials or Monogram of Filler
		White	6mm (0.236 in)	Date of filling, month and year
		White	6mm (0.236 in)	Lot No. UNDERLINED (word "LOT" not to be marked)

Table 5-8. Painting and Marking of Grenade, Discharger, Anti-Riot, Practice, L97A1.

Grenade	Body color	Color of markings	Height of letters (in.)	Marking
L97A1	Deep Saxe Blue to BS381C No. 113	White	8mm (0.315 in)	GREN DSCHGR A/Riot PRAC L97A1
		Middle Brown BS381C No. 411	5mm (0.200 in)	Brown Band
		Eau De Nil BS381C No. 216	5mm (0.200 in)	Eau De Nil (Light Green) Band
		White	6mm (0.236)	Initials or Monogram of Filler
		White	6mm (0.236 in)	Date of filling, month and year
		White	6mm (0.236 in)	Lot No. UNDERLINED (word "LOT" not to be marked)

Table 5-9. Painting and Marking of Grenade, Launcher: Non-Lethal, Distraction, M98.

Grenade	Body color	Color of markings	Height of letters (in.)	Marking
M98	Green No. 34540	Black No. 37038	0.25 +/- 0.05	GREN LCHR NON-LETHAL DISTRACTION M98
		Brown No. 30117 or No. 30140	0.31	Brown Band
		Black No. 37038	0.25 +/- 0.05	Black Band
		Black No. 37038	0.25	Lot Number
		Black No. 37038	6.0 x 6.0	M98 Pattern Photograph, Dwg 13-19-741

Table 5-10. Painting and Marking of Grenade, Launcher: Non-Lethal, Blunt Trauma, M99.

Grenade	Body color	Color of markings	Height of letters (in.)	Marking
M99	Green No. 34540	Black No. 37038	0.25 +/- 0.05	GREN LCHR NON-LETHAL BLUNT TRAUMA M99
		Brown No. 30117 or No. 30140	0.31	Brown Band
		Black No. 37038	0.25 +/- 0.05	Black Band
		Black No. 37038	0.25	Lot Number
		Black No. 37038	6.0 x 6.0	M99 Pattern Photograph, Dwg 13-19-740

(1) Receive grenade from rust removal operation.

(2) Apply masking tape over all areas to be protected from enamel, especially over movable portions of hand grenade fuze to prevent possible interference with proper functioning (fig. 5-1). Leave prongs of hand grenade safety pin fully exposed.

(3) Attach hand grenade suspension device (fig. 5-2) beneath lever, between lever and body as shown in figure 5-3. Suspend rifle grenade as shown in figure 5-4.

(4) Apply protective coating.

(a) *Dip Method.* While suspending grenade as shown in figure 5-5, dip body portion in enamel. Keep grenade body and fuze joint above surface of paint.

WARNING

WEAR PAINT SPRAY RESPIRATOR.

(b) *Spray Method.* While suspending grenade, apply protective coating with paint spray gun or aerosol spray can, if available. Reposition grenade as necessary to expose uncoated portion, then repeat operation to complete coverage.

(5) Hang suspended grenade on rack (fig. 5-2) until coating dries.

(6) Apply masking tape in order to paint body union or rifle grenade.

(7) Allow paint on body union to dry.

(9) Material, tools, and equipment include the following:

- (a) Enamel
- (b) Solvent
- (c) Rags
- (d) Spray outfit, paint
- (e) Can, safety, flammable liquid
- (f) Gloves, disposable
- (g) Suspension device - to be made on site from cord exceeding 25 pound pull capability and tied with square knot (fig. 5-2).
- (h) Tape, masking
- (i) Respirator

c. *Remark Grenade.* For specific markings, see tables 5-1 through 5-8.

CAUTION

CLEAN ALL MARKING EQUIPMENT AT END OF EACH SHIFT OR TERMINATION OF JOB, WHICH-EVER COMES FIRST, AND AS OFTEN AS NECESSARY TO FACILITATE USE DURING OPERATIONS. DISPOSE OF WASTE CONTAMINATED WITH PAINTS AND SOLVENTS BY SUBMERGING IN WATER IN APPROVED WASTE CAN TO AWAIT BURNING.

(1) Receive grenade from supply operator.

(a) *Rubber Type Method.*

1. Apply a small dab of paint to paint plate and roll out well with brayer.
2. Roll brayer back and forth on paint plate to distribute paint on brayer.
3. Roll painted brayer lightly across face of rubber type to apply light film of ink to type.
4. Place grenade in position to receive marking, then roll carefully across face of rubber type to apply paint marking to grenade.

(b) *Stencil Method.*

1. Apply small dab of paint to paint plate.
2. Rub brush in paint to apply to bristles.

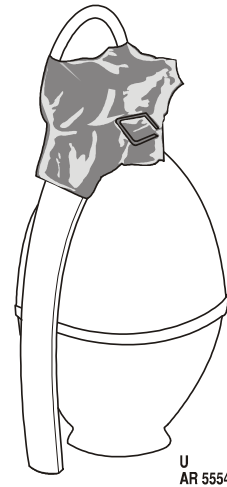

Figure 5-1. Application of masking tape to grenade.

3. Position stencil cut out over location on grenade to receive marking.
4. While holding stencil cut out firmly against grenade, rub bristles of brush over stencil to apply inked marking to grenade.
5. Remove stencil cut out.

(2) Check markings to assure they are correct, neat and legible.

(3) Transfer marked grenade to next operation. Transfer grenades not requiring refuzing to operation for assembling safety clip to grenade.

(4) Material, tools and equipment include the following.

(a) *Paint.*

- (b) Solvent.
- (c) Rags.
- (d) Rubber type, mounted (alt) stencil and stencil brush.
- (e) Table, work.
- (f) Can, safety, plunger-type.
- (g) Gloves, disposable.

d. *Defuze Grenade, Hand (General Support Maintenance Only)*. For defuzing operations, see paragraph 105c(6), TM 9-1300-206.

NOTE

When positioning torque wrench in vise, care will be taken to insure that only the gripping portion of the wrench handle is clamped in vise. The vise should be equipped with wooden inserts to prevent damaging torque wrench.

- (1) Place torque wrench in vise.
- (2) Receive grenade from preceding operation. Engage fuze body in fuze wrench adapter. See figure 5-6.

WARNING

DO NOT USE IN EXCESS OF 100 INCH-POUNDS TO LOOSEN FUZE. GRENADES WITH FUZES REQUIRING IN EXCESS OF 100 INCH-POUNDS TO LOOSEN WILL BE REPACKED FOR SUBSEQUENT DISPOSAL OR REWORK BY DEPOT OR LOADING PLANT PERSONNEL AND FACILITIES.

- (3) Grasp grenade body, while observing torque indicator, turn body in counterclockwise direction until completely unscrewed from grenade fuze.
- (4) Remove grenade body from fuze.

(5) Place fuze in packing support of shielded tray (fig. 5-7). Transfer to inspection operation or fuze packing operation as required.

(6) Tools and equipment include the following:

- (a) Work table.
- (b) Vise, machinist 4 to 6 inches wide jaw with wooden inserts.
- (c) Wrench, torque 3/8 male sq-drive, 150 in. lb capacity.
- (d) Adapter, fuze wrench.
- (e) Support, packing (fig. 5-7).
- (f) Pitch-in barricade (fig. 5-8).

e. *Inspect Fuze, Grenade, Hand.*

(1) Receive grenade fuzes from preceding operation or from supply operator. Check lot number and nomenclature to assure fuzes are those for intended work.

(2) Inspect each fuze for defects specified in paragraph 4-6d.

(3) Place acceptable grenade fuzes in sectionalized tray and transfer to next operation.

(4) Place defective fuzes in sectionalized reject tray for transfer to destruction area.

(5) Tools and equipment include the following:

- (a) Work table.
- (b) Fuze tray, support packing (fig. 5-7).
- (c) Pitch-in, barricade (fig. 5-8).

f. *Assemble Fuze to Hand Grenade (General Support Maintenance Only)*.

(1) Receive grenade and fuze from preceding operations.

(2) After assuring safe condition of safety pin, remove from tray or packing support.

(3) If M204A1 or M204A2 Fuze, assemble fiberglass sleeve over fuze delay column housing. Sleeve should slide over fuze housing and butt against shoulder under threads. Adjust or replace if necessary.

(4) Use small brush or equal to coat fuze threads with prescribed adhesive.

(5) Obtain grenade and check to assure fuze well is free of foreign material or any obstruction capable of interfering with assembling of fuze.

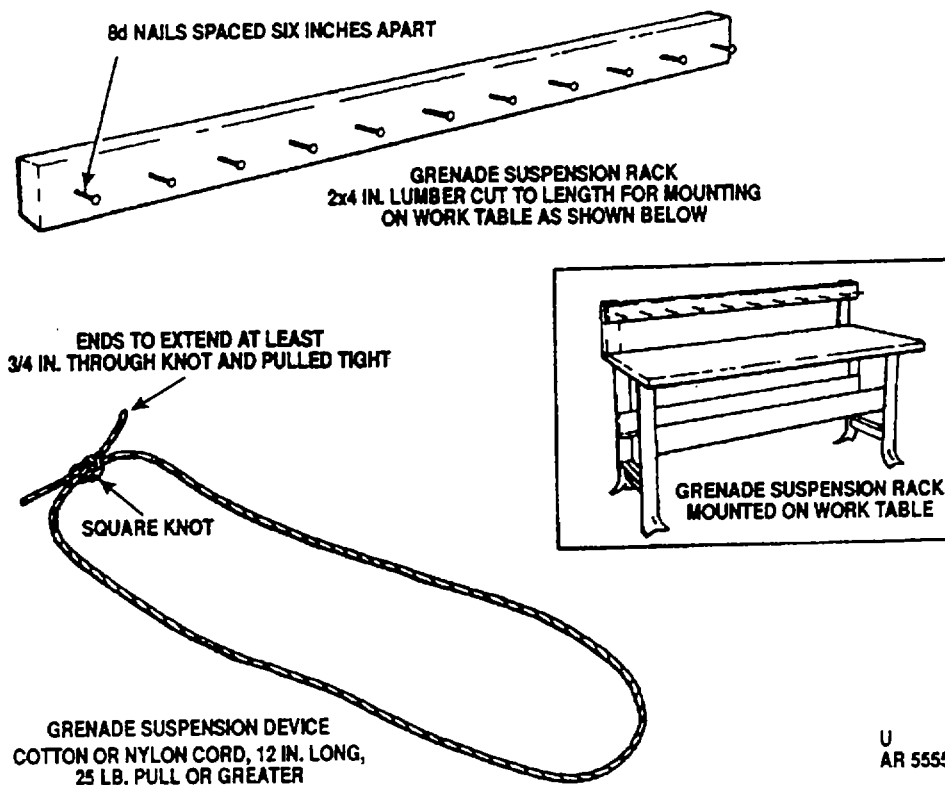

Figure 5-2. Grenade suspension device and rack.

WARNING

- DO NOT ATTEMPT TO ASSEMBLE FUZE TO GRENADE BEFORE ASSURING THAT FUZE WELL IS FREE OF OBSTRUCTIONS.
- IF FUZE FAILS TO SEAT WITH LIGHT HAND PRESSURE IT IS AN INDICATION THAT OBSTRUCTION IS PRESENT, OR THAT FUZE OR GRENADE IS DEFECTIVE. DO NOT FORCE. REMOVE FUZE AND CHECK FOR DEFECTIVE CONDITION.

(6) Assemble fuze to grenade hand tight. When assembling M206A2 fuze to Hand-Rifle grenade M34 or to Offensive Hand Grenade MK3, assemble safety clip to fuze prior to assembling fuze to grenade.

(7) Transfer grenade to next operation for torquing before adhesive sets.

(8) Material, tools and equipment include the following:

- (a) Adhesive.
- (b) Solvent.

- (c) Rags.
- (d) Can, safety, flammable liquid.
- (e) Gloves, disposable.
- (f) Fiber glass tubing, if required.

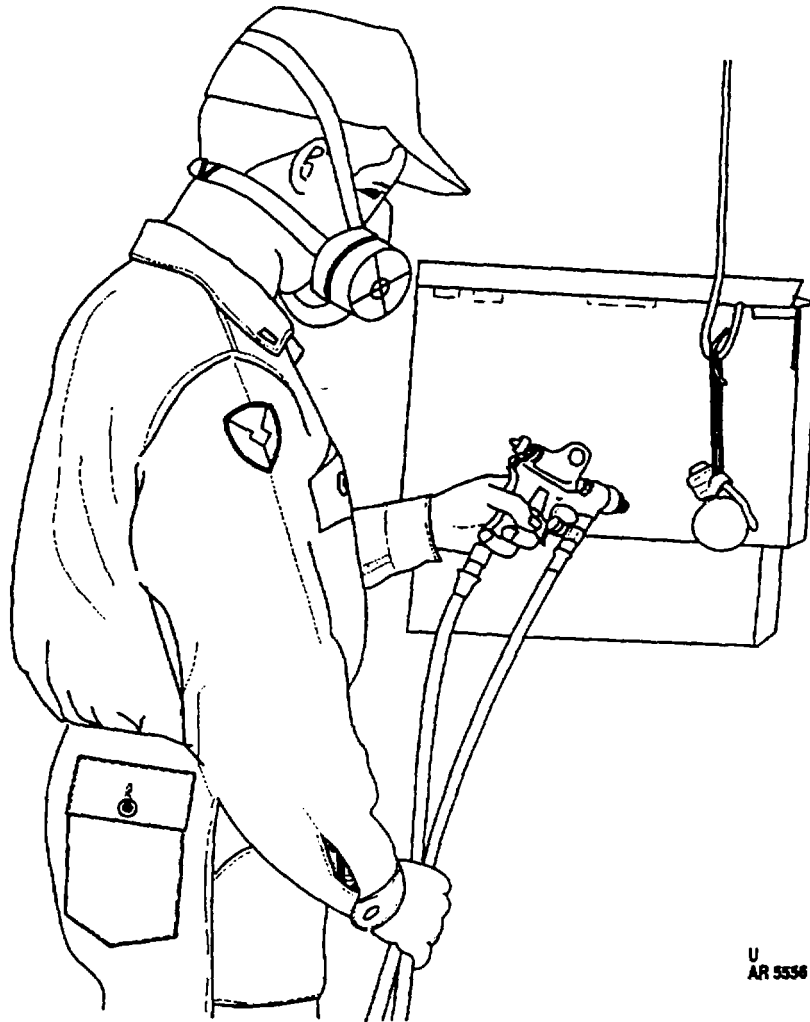

Figure 5-3. Spray painting of hand grenade.

g. Torque fuze to Hand Grenade (General Support Maintenance Only).

- (1) Receive fused grenade from preceding operation.
- (2) Engage fuze body in fuze wrench adapter. See figure 5-6.

WARNING

DO NOT USE IN EXCESS OF THE MAXIMUM PRESCRIBED TORQUE IN ACCORDANCE WITH THE APPLICABLE DRAWINGS.

- (3) Grasp grenade body. Tighten grenade body to prescribed torque prior to adhesive setting.

(4) Remove fuzeed grenade from fuze adapter and transfer to next operation.

(5) Material, tools and equipment include the following:

(a) Work table.

(b) Wrench, torque 3/8 male sq-drive, 150 in.-lb capacity.

(c) Adapter, fuze, wrench.

(d) Vise, mechanical, with wooden jaws.

(e) Pitch-in barricade (fig. 5-8).

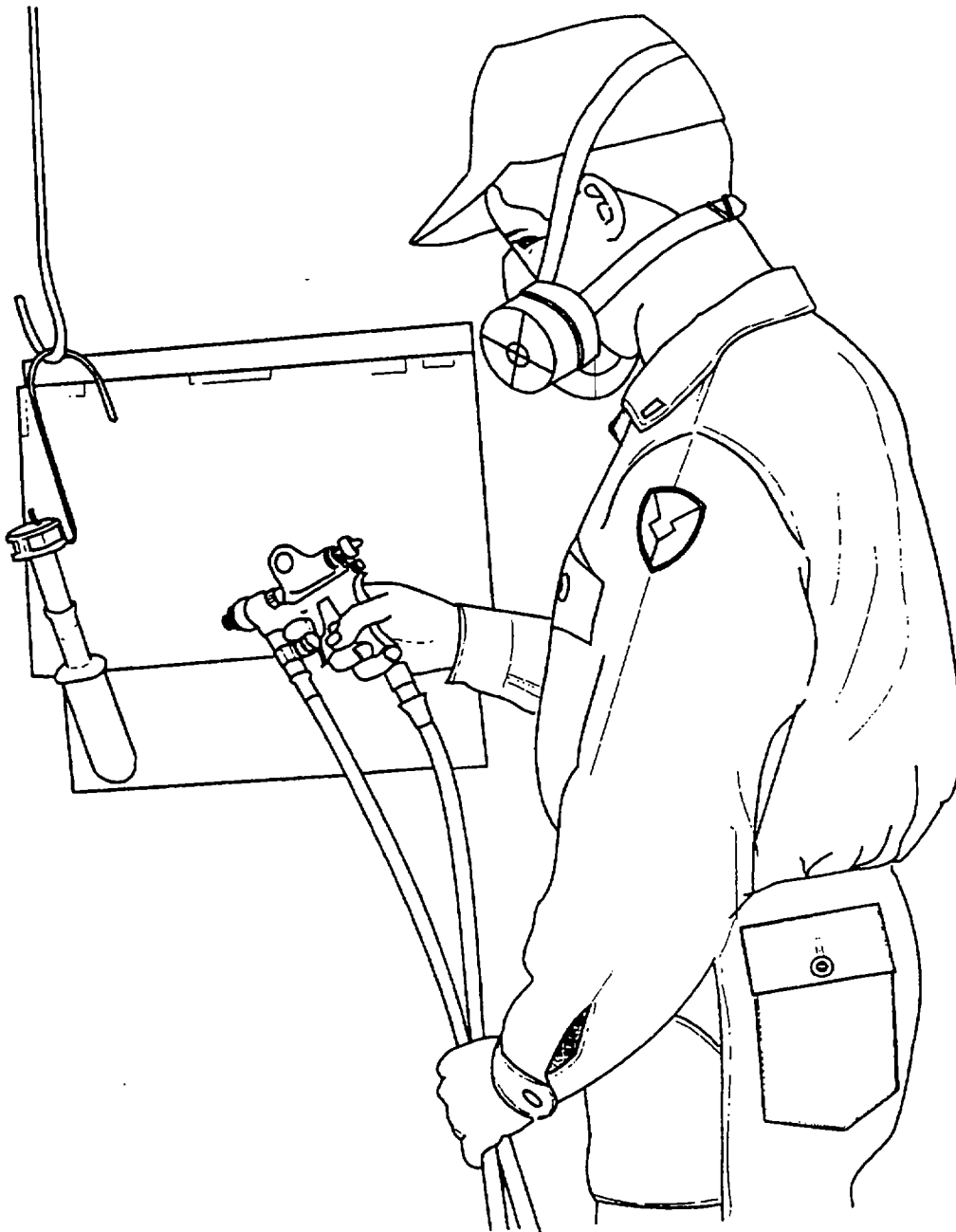

U
AR 5557

Figure 5-4. Spray painting of rifle grenade.

h. *Assemble Safety Clip to Grenade.*

(1) Receive grenade from preceding operation. Receive safety clips from supply operator or obtain from holding area as required.

(2) Check safety clip immediately before assembly to grenade. Dispose of damaged or otherwise defective clips.

(3) Assemble safety clip to fuze, see paragraph 3-7a(7), TM 9-1330-200-12.

(4) Transfer grenade to next operation.

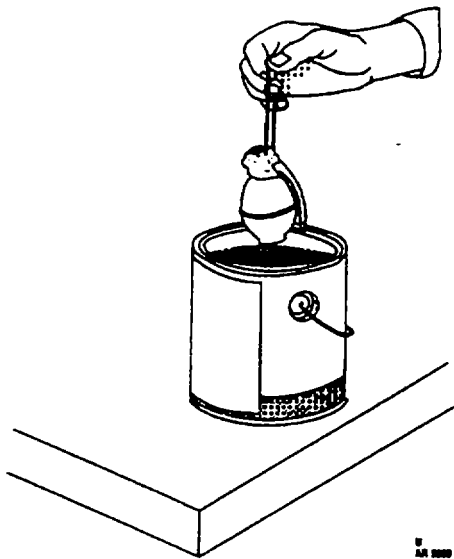

Figure 5-5. Dip painting of grenade.

(5) Material, tools and equipment include the following:

- (a) Table, work.
- (b) Clips, safety.
- (c) Receptacle, waste.

i. *Inspect and Recondition Packing Box.*

(1) Receive packing box from unpacking operation.

(2) Examine box and repair, recondition, accept or reject as instructed in paragraph 4-6e.

(3) Transfer accepted packing box to packing operation. If rejected, mark and place in reject area pending disposal.

(4) Materials, tools and equipment include the following:

- (a) Table, work.
- (b) Conveyor, roller.
- (c) Scraper, wood.
- (d) Rags, waste.
- (e) Hammer, claw.
- (f) Puller, nail, hand.
- (g) Stencil or type, rubber (to be made on site).
- (h) Screwdriver.
- (i) Brush, paint.
- (j) Ink, marking.
- (k) Enamel.
- (l) Solvent.

j. *Inspect and Recondition Packing Container.*

(1) Receive packing container from grenade unpacking operation.

(2) Inspect container and repair, recondition, accept or reject as instructed in paragraph 4-6e.

(3) Transfer accepted container to packing operation. If rejected, mark and place in reject area pending disposal.

(4) Material, tools and equipment include the following:

- (a) Table, work.
- (b) Rags, waste,
- (c) (c) Stencil or rubber type.
- (d) Brush, paint.

- (e) Ink, marking.
- (f) Paint, acid-proof, black.
- (g) Solvent.

k. *Repack Hand Grenade in Container.*

(1) Receive grenade and packing material from preceding operations.

(2) Open container and remove filler and support.

(3) Place one filler into container.

(4) Place grenade, fuze end up, into container with pull ring in down position.

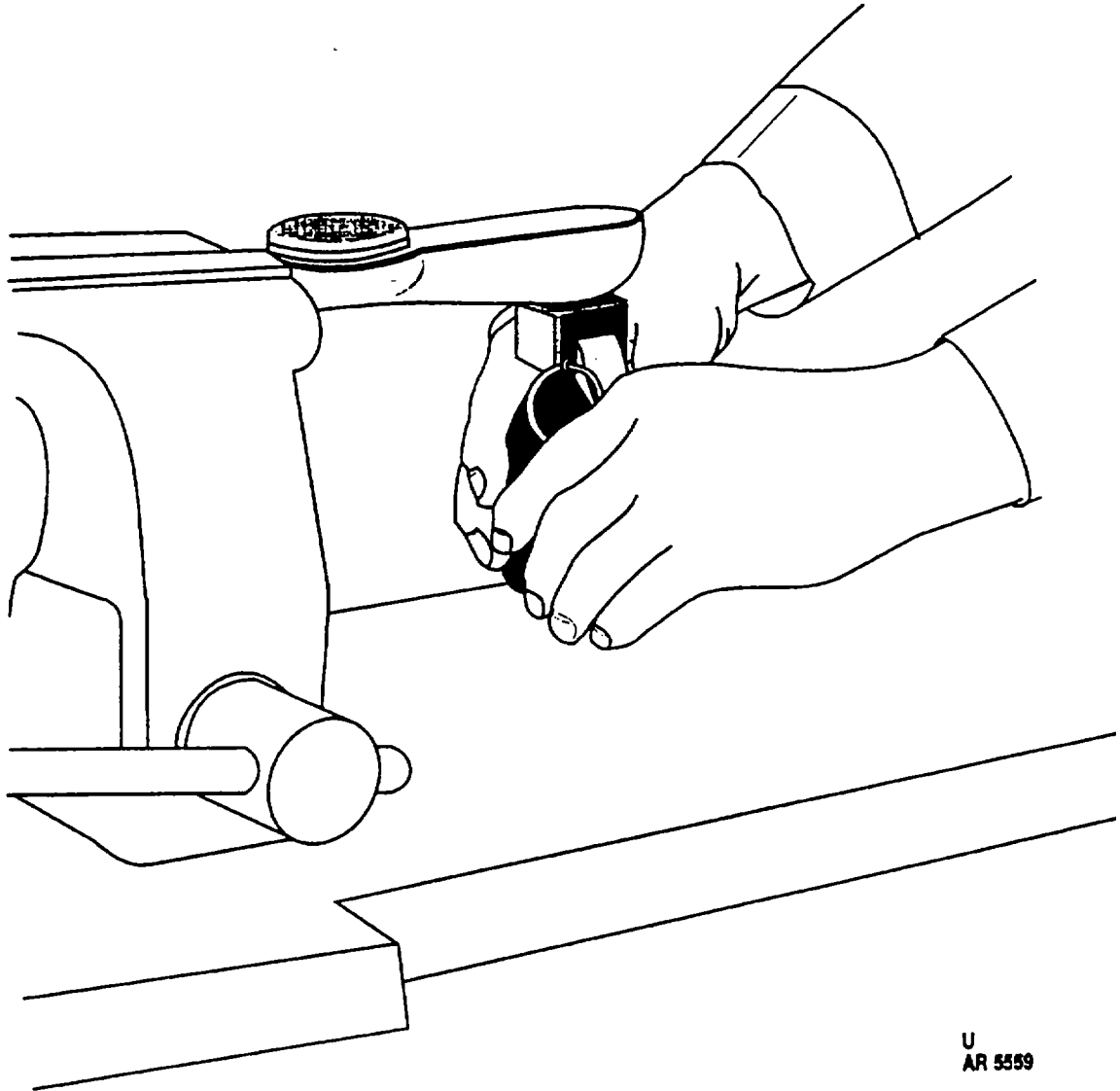

U
AR 5559

Figure 5-6. Defuzing or torquing of hand grenade fuze.

(5) Place plastic support atop fuze with forward (lug) end of fuze body toward radius portion of recess.

(6) Place one or more fillers atop support as required to provide a tight pack.

(7) Assemble and seat cover on container.

(8) Transfer closed container to next operation.

(9) Material, tools and equipment include a work table.

I. *Tape Container*

(1) Receive packed grenade in container from preceding operation.

(2) While holding container firmly together, apply one and one-fourth wraps of pressure sensitive tape around joint formed by tip and bottom of container, leaving a one and one-half inch pull tab. When applying tape to container, use at least 10 pounds tension. Assure gap between container top and bottom does not exceed 1/8 inch.

(3) Transfer sealed container to next operation.

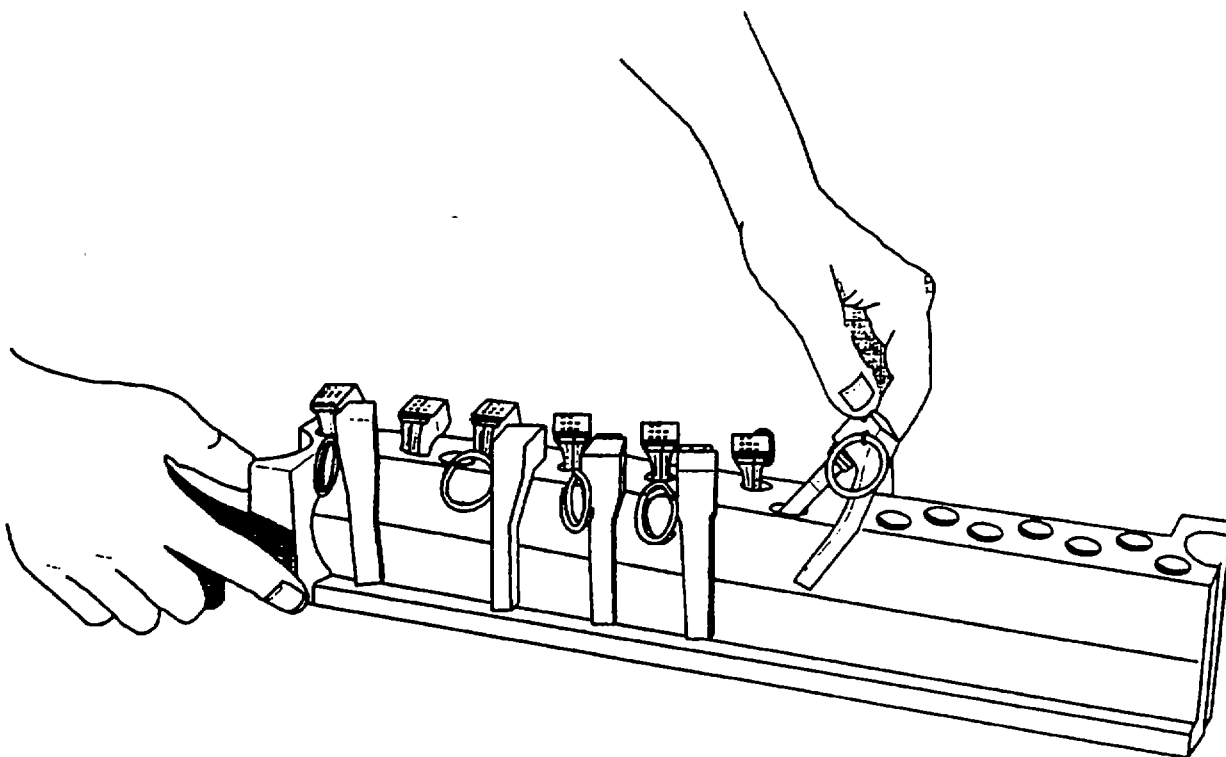

U
AR 5560

Figure 5-7. Placing fuze in packing support.

(4) Materials. Tools and equipment include the following:

- (a) Table, work.
- (b) Tape, pressure sensitive.

m. Pack Sealed Containers in Box.

(1) Receive sealed container and packing material from preceding operations.

(2) Insert sealed container, tip end up, into packing box to form complete rows lengthwise and widthwise.

(3) Place filler atop containers. Continue packing containers if required, to complete second layer.

(4) Add sufficient fillers to ends, side, and top as required to assure a tight pack.

(4) Materials. Tools and equipment include the following:

(a) Table, work.

(b) Tape, pressure sensitive.

m. *Pack Sealed Containers in Box.*

(1) Receive sealed container and packing material from preceding operations.

(2) Insert sealed container, tip end up, into packing box to form complete rows lengthwise and widthwise.

(3) Place filler atop containers. Continue packing containers if required, to complete second layer.

(4) Add sufficient fillers to ends, side, and top as required to assure a tight pack.

(5) Close cover and transfer box to next operation.

n. *Seal and Strap Packing Box.*

(1) Receive packed grenade in box from preceding operation.

(2) Swing hasp over swivel and turn swivel 180° to latch hasp.

(3) Pass seal wire through eye in swivel and back through eye in hasp.

(4) Draw end of wire through hole in seal and pull taut to remove slack.

(5) Conceal end of wire in lead seal and crimp seal with hand lead seal press.

(6) Repeat operation to seal remaining hasp and swivel, if present.

(7) Assemble and secure metal strapping tightly around box using hand strapping machine. Do not obstruct marking. Repeat operation, if necessary to apply second strap.

(8) Transfer sealed and strapped box to carrier for return to storage site.

(9) Material, tools, and equipment include the following:

(a) Conveyor.

(b) Strapping and sealing kit: 5/8 inch wide x 0.023 inch thick strapping.

(c) Press, lead seal, hand.

(d) Seal wires and seals.

(e) Gloves, leather palm.

(f) Face shield or safety goggles.

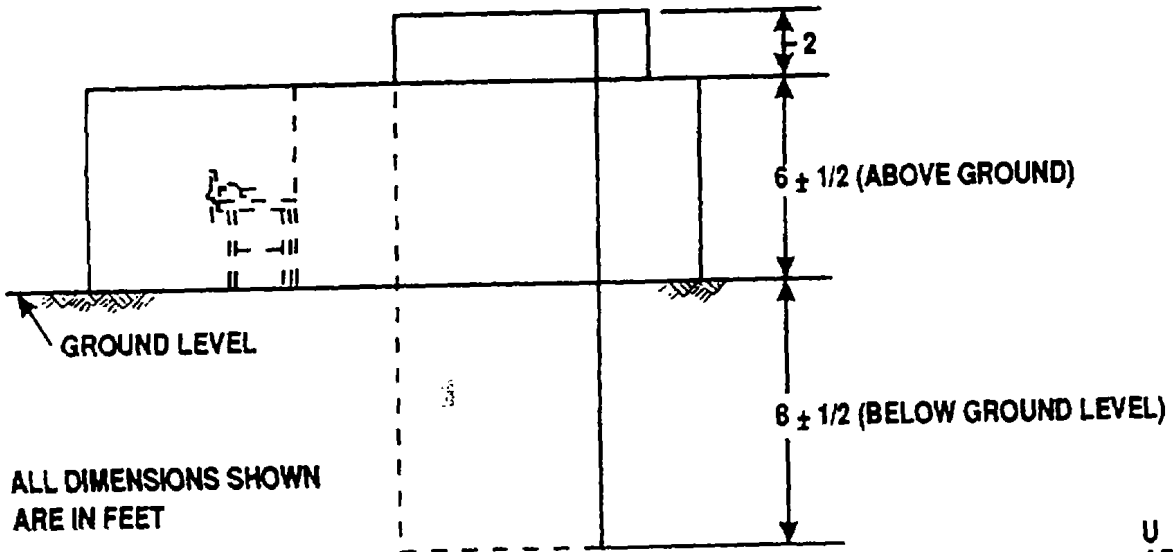
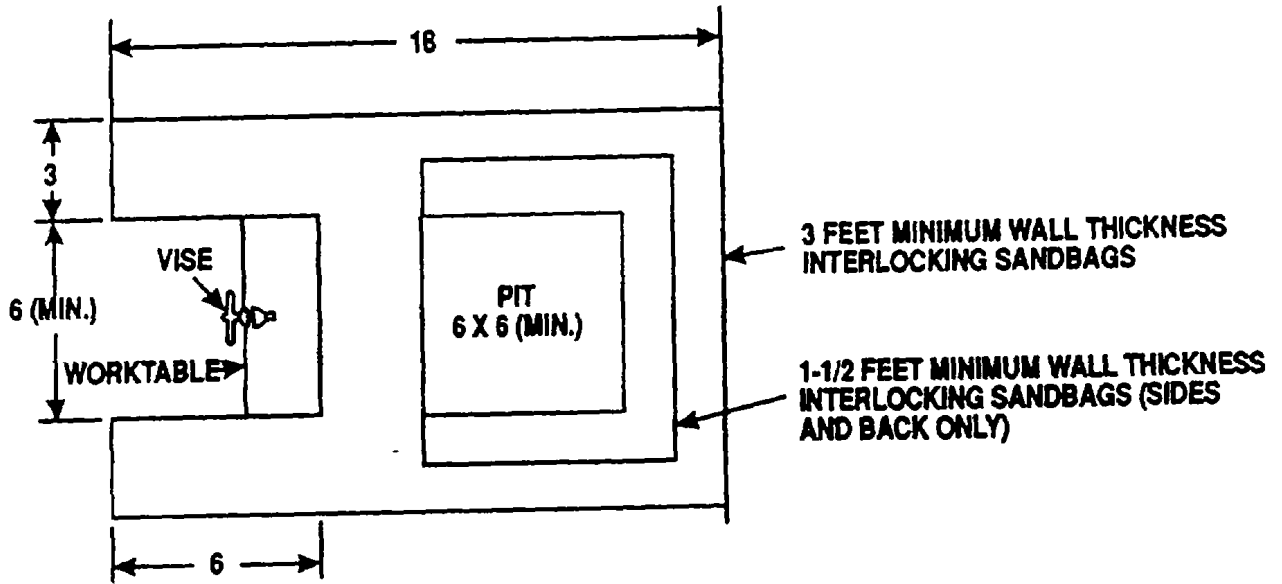

NOTE: ALL DIMENSIONS SHOWN ARE IN FEET

U
AR 5561

Figure 5-8. Pitch-in barricade.

APPENDIX A REFERENCES

A.1 SCOPE.

This appendix lists all Army regulations, field manuals, forms, pamphlets, supply catalogs, technical manuals, and miscellaneous publications referenced in this manual. The publication index (DA Pam 25-30) should be consulted frequently for latest changes or revisions of references given in this appendix and for new publications relating to the material covered in this manual.

A.2 ARMY REGULATIONS.

U.S. Army Explosive Safety Program AR 386-64

A.3 FIELD MANUALS.

Grenades and Pyrotechnic Signals FM 3-23.30

A.4 FORMS.

Munition Surveillance Report DA Form 984-R

Recommended Changes to Publications and Blank Forms..... DA Form 2028

A.5 PAMPHLETS.

Consolidated Index of Army Publications and Blank Forms..... DA Pam 25-30

Ammunition and Explosives Safety Standards DA Pam 385-64

The Army Maintenance Management System (TAMMS) Users Manual..... DA Pam 750-8

A.6 SUPPLY CATALOGS.

Tool Set, Ammunition: Field Maintenance Ordnance Ammunition Company
(4940-322-6058) (Line Item W59582) MAP Only (4940-919-0113)..... SC 4940-95-A11

A.7 TECHNICAL MANUALS.

Operator's and Unit Maintenance Manual (Including RPSTL) for Light Vehicle Obscuration
Smoke System (LVOSS) TM 3-1040-286-12&P

Operator's and Unit Maintenance Manual (Including RPSTL) for Installation Kit, Grenade
Launcher, Adjustable, Multi-purpose, 66mm, Turret Mount, M315 TM 3-1055-649-12&P

Organizational Maintenance Manual (Including RPSTL): Launcher, Grenade, Smoke,
Screening, RP M239 (NSN 1040-01-015-0874)..... TM 9-1040-266-20&P

Ammunition, General..... TM 9-1300-200

Ammunition Maintenance..... TM 9-1300-250

A.7 TECHNICAL MANUALS.

Operator's and Unit Maintenance Manual for Grenades	TM 9-1330-200-12
Army Ammunition Data Sheets for Grenades	TM 43-0001-29

A.8 MISCELLANEOUS PUBLICATIONS.

Ordnance Company, Ammunition DS (MOADS-PLS)	TOE 09484L000
Ordnance Company, Ammunition GS (MOADS-PLS) CSA	TOE 09433L000
Ordnance Company, Ammunition GS (MOADS-PLS)	TOE 09633L000

**APPENDIX B
MAINTENANCE SUPPLIES**

Section I. INTRODUCTION

B-1. Scope

This appendix lists expendable items which are required for direct and general support maintenance.

B-2. Explanation of Columns in the Tabular List of Expendable Materials, Section II

a. *National Stock No.* Column 1 indicates the national stock number assigned to the item and shall be used for requisitioning purposes.

b. *Description.* Column 2 indicates the Federal item name and the minimum description to identify the item.

c. *Specification No.* Column 3 indicates the specification which controls the design or characteristics of the item.

d. *Unit of Issue.* Column 4 indicates the unit of issue of each maintenance supply item.

Section II. EXPENDABLE MATERIALS

NOTE

Materials should be stocked and requisitioned through normal supply channels on an as required basis.

(1) National Stock No.	(2) Description	(3) Specification No.	(4) Unit of Issue
8040-00-264-5840	ADHESIVE: Thermoplastic, synthetic rubber for hot or cold bonding.	MMM-A-189	gl
7920-00-255-5135	BRUSH: Wire Scratch, wood and copper-beryllium alloy with curved handle, 14 in. x 15/16 in. block, 6 in. x 1 1/4 in. wire brush.	H-B-178	ea
7920-00-269-0933	BRUSH: Wire Scratch, wood and copper-beryllium alloy, straight block, 7 in. x 1 in. block, 6 in. x 1 1/4 in. wire brush.	H-B-178	ea
8010-00-597-5301	BRUSH: Paint, oval style, angular, type 1, class 1, size 6.	H-B-491	ea
7240-00-282-8411	CAN: Flammable Waste, 6 gallon capacity	R-R-C-114	ea
8030-00-290-5141	COATING COMPOUND: Bituminous Solvent, Type 2, medium solids, brushing and spraying consistency.	MIL-C-450	gl
8030-00-664-7105	COATING COMPOUND: Bituminous Solvent, Type 1, low solids, spraying consistency.	MIL-C-450	gl
8010-00-297-2122	ENAMEL: Black, No. 37038	TT-E-516	gl
8010-00-297-2119	Blue, light, No. 35109	TT-E-516	gl

(1) National Stock No.	(2) Description	(3) Specification No.	(4) Unit of Issue
8010-00-297-2120	Gray, No. 36231	TT-E-516	gl
8010-00-598-5939	Green, dark, No. 34108	TT-E-516	gl
8010-00-828-3193	Green, light, No. 34558	TT-E-516	gl
8010-00-297-2116	Olive, drab, No. 34087	TT-E-516	gl
8010-00-297-2113	Olive, drab, No. 34087	TT-E-516	gl (5)
8010-00-848-9272	Olive, drab, No. 34087	TT-E-16	pt (spray)
8010-00-577-4937	Red, No. 31168	TT-E-516	qt
8010-00-297-2114	Red, light, No. 31136	TT-E-516	gl
8010-00-297-2111	White, No. 37875	TT-E-516	gl
8010-00-878-5761	White, No. 37875	TT-E-516	pt (spray)
8010-00-297-2112	Yellow, No. 33538	TT-E-516	gl
8415-00-634-4646	GLOVES: Cloth, knit wristlet, (71983).	JJ-G-451	pr
8415-00-682-6786	GLOVES: Plastic, disposable (71983).	PINKIES	pr
	INK, MARKING STENCIL:		
7510-00-161-0811	Black, f/porous surface	TT-I-1795	gl
7510-00-161-0815	White, f/porous surface	TT-I-1795	gl
7510-00-161-0812	Gray, f/porous surface	TT-I-1795	gl
7510-00-161-0814	Red, f/porous surface	TT-I-1795	gl
7510-00-161-0810	Green, f/porous surface	TT-I-1795	gl
7510-00-191-6030	Black, f/nonporous surface	TT-I-1795	gl
7510-00-224-6733	Yellow, f/nonporous surface	TT-I-1795	pt
7510-00-1394457	Brown, f/porous surface	TT-I-1795	pt
8010-00-063-8968	LACQUER: Brown, No. 30117	MIL-L-1195	gl
5110-00-293-3209	PLIERS: Diagonal cutting	GGG-P-468	ea
7920-00-205-1711	RAG: Wiping, cotton unbleached	DDD-R-30	bl (50 lb)
8030-00-656-1426	SEALING COMPOUND: Thread and gasket, non-hardening (low viscosity)	MIL-D-45180	pt
7510-00-198-5831	TAPE, MASKING: 1 in. width	UU-T-93	ro (60yd)
7510-00-823-8073	TAPE, PRESSURE: Black, 1 f12-in. wide, type 1	MILT-43036	ro (60yd)
8010-00-160-5788	THINNER: Clear, for dope and lacquer	TT-T-266	gl
8010-00-242-2089	THINNER: Paint, mineral spirits	TT-T-291	gl
8010-00-160-5794	THINNER: Synthetic, for use with alkyd resin enamels	TT-T-306	gl

By Order of the Secretary of the Army and Commandant of the Marine Corps:

GORDON R. SULLIVAN
General, United States Army
Chief of Staff

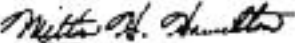
Official: 
MILTON H. HAMILTON
Administrative Assistant to the
Secretary of the Army
04586

RONALD D. ELLIOTT
Executive Director
Marine Corps Systems Command

★U.S. GOVERNMENT PRINTING OFFICE : 1994 0 - 155-664

RECOMMENDED CHANGES TO PUBLICATIONS AND BLANK FORMS For use of this form, see AR 25-30; the proponent agency is ODISC4.						Use Part II (<i>reverse</i>) for Repair Parts and Special Tool Lists (RPSTL) and Supply Catalogs/Supply Manuals (SC/SM).	DATE
TO: (<i>Forward to proponent of publication or form</i>) (<i>Include ZIP Code</i>)						FROM: (<i>Activity and location</i>) (<i>Include ZIP Code</i>)	
PART I - ALL PUBLICATIONS (EXCEPT RPSTL AND SC/SM) AND BLANK FORMS							
PUBLICATION/FORM NUMBER TM 9-1375-225-12						DATE 18 Jun 99	TITLE SOF Demo Kit, M303
ITEM NO.	PAGE NO.	PARA-GRAPH	LINE NO.*	FIGURE NO.	TABLE NO.	RECOMMENDED CHANGES AND REASON <i>(Provide exact wording of recommended changes, if possible).</i>	
1	1-2	1.2.4				Change "Rock Island, IL 61201" to read "Aberdeen Proving Ground, MD 21010". Reason: Wrong Address.	
2	2-3			2-6		Add "LOCKWASHER" to the illustration. Reason: Missing from illustration.	
<i>* Reference to line numbers within the paragraph or subparagraph.</i>							
TYPED NAME, GRADE OR TITLE						TELEPHONE EXCHANGE/AUTOVON, PLUS EXTENSION	SIGNATURE

SAMPLE

This Page Intentionally Left Blank

RECOMMENDED CHANGES TO PUBLICATIONS AND BLANK FORMS <small>For use of this form, see AR 25-30; the proponent agency is ODISC4.</small>						<small>Use Part II (reverse) for Repair Parts and Special Tool Lists (RPSTL) and Supply Catalogs/Supply Manuals (SC/SM).</small>	<small>DATE</small>
<small>TO: (Forward to proponent of publication or form) (Include ZIP Code)</small> LRED (AMSRD-AAR-AIL-LS) U.S. Army RDECOM, ARDEC Picatinny Arsenal, NJ 07806-5000						<small>FROM: (Activity and location) (Include ZIP Code)</small>	
PART I - ALL PUBLICATIONS (EXCEPT RPSTL AND SC/SM) AND BLANK FORMS							
<small>PUBLICATION/FORM NUMBER</small> TM 9-1330-200-34						<small>DATE</small> 15 July 1993	<small>TITLE</small> Direct Support and General Support Maintenance Manual for Grenades
<small>ITEM NO.</small>	<small>PAGE NO.</small>	<small>PARA-GRAPH</small>	<small>LINE NO.*</small>	<small>FIGURE NO.</small>	<small>TABLE NO.</small>	<small>RECOMMENDED CHANGES AND REASON (Provide exact wording of recommended changes, if possible).</small>	
<small>* Reference to line numbers within the paragraph or subparagraph.</small>							
<small>TYPED NAME, GRADE OR TITLE</small>				<small>TELEPHONE EXCHANGE/AUTOVON, PLUS EXTENSION</small>		<small>SIGNATURE</small>	

TO: <i>(Forward direct to addressee listed in publication)</i> LRED (AMSRD-AAR-AIL-LS) U.S. Army RDECOM, ARDEC Picatinny Arsenal, NJ 07806-5000	FROM: <i>(Activity and location) (Include ZIP Code)</i>	DATE
--	--	-------------

PART II - REPAIR PARTS AND SPECIAL TOOL LISTS AND SUPPLY CATALOGS/SUPPLY MANUALS

PUBLICATION NUMBER			DATE	TITLE				
PAGE NO.	COLM NO.	LINE NO.	NATIONAL STOCK NUMBER	REFERENCE NO.	FIGURE NO.	ITEM NO.	TOTAL NO. OF MAJOR ITEMS SUPPORTED	RECOMMENDED ACTION

PART III - REMARKS *(Any general remarks or recommendations, or suggestions for improvement of publications and blank forms. Additional blank sheets may be used if more space is needed.)*

TYPED NAME, GRADE OR TITLE	TELEPHONE EXCHANGE/AUTOVON, PLUS EXTENSION	SIGNATURE
----------------------------	--	-----------

RECOMMENDED CHANGES TO PUBLICATIONS AND BLANK FORMS <small>For use of this form, see AR 25-30; the proponent agency is ODISC4.</small>						<small>Use Part II (reverse) for Repair Parts and Special Tool Lists (RPSTL) and Supply Catalogs/Supply Manuals (SC/SM).</small>	<small>DATE</small>
<small>TO: (Forward to proponent of publication or form) (Include ZIP Code)</small> LRED (AMSRD-AAR-AIL-LS) U.S. Army RDECOM, ARDEC Picatinny Arsenal, NJ 07806-5000						<small>FROM: (Activity and location) (Include ZIP Code)</small>	
PART I - ALL PUBLICATIONS (EXCEPT RPSTL AND SC/SM) AND BLANK FORMS							
<small>PUBLICATION/FORM NUMBER</small> TM 9-1330-200-34						<small>DATE</small> 15 July 1993	<small>TITLE</small> Direct Support and General Support Maintenance Manual for Grenades
<small>ITEM NO.</small>	<small>PAGE NO.</small>	<small>PARA-GRAPH</small>	<small>LINE NO.*</small>	<small>FIGURE NO.</small>	<small>TABLE NO.</small>	<small>RECOMMENDED CHANGES AND REASON (Provide exact wording of recommended changes, if possible).</small>	
<small>* Reference to line numbers within the paragraph or subparagraph.</small>							
<small>TYPED NAME, GRADE OR TITLE</small>				<small>TELEPHONE EXCHANGE/AUTOVON, PLUS EXTENSION</small>		<small>SIGNATURE</small>	

TO: <i>(Forward direct to addressee listed in publication)</i> LRED (AMSRD-AAR-AIL-LS) U.S. Army RDECOM, ARDEC Picatinny Arsenal, NJ 07806-5000	FROM: <i>(Activity and location) (Include ZIP Code)</i>	DATE
--	--	-------------

PART II - REPAIR PARTS AND SPECIAL TOOL LISTS AND SUPPLY CATALOGS/SUPPLY MANUALS

PUBLICATION NUMBER			DATE	TITLE				
PAGE NO.	COLM NO.	LINE NO.	NATIONAL STOCK NUMBER	REFERENCE NO.	FIGURE NO.	ITEM NO.	TOTAL NO. OF MAJOR ITEMS SUPPORTED	RECOMMENDED ACTION

PART III - REMARKS *(Any general remarks or recommendations, or suggestions for improvement of publications and blank forms. Additional blank sheets may be used if more space is needed.)*

TYPED NAME, GRADE OR TITLE	TELEPHONE EXCHANGE/AUTOVON, PLUS EXTENSION	SIGNATURE
----------------------------	--	-----------

RECOMMENDED CHANGES TO PUBLICATIONS AND BLANK FORMS <small>For use of this form, see AR 25-30; the proponent agency is ODISC4.</small>						<small>Use Part II (reverse) for Repair Parts and Special Tool Lists (RPSTL) and Supply Catalogs/Supply Manuals (SC/SM).</small>	<small>DATE</small>
<small>TO: (Forward to proponent of publication or form) (Include ZIP Code)</small> LRED (AMSRD-AAR-AIL-LS) U.S. Army RDECOM, ARDEC Picatinny Arsenal, NJ 07806-5000						<small>FROM: (Activity and location) (Include ZIP Code)</small>	
PART I - ALL PUBLICATIONS (EXCEPT RPSTL AND SC/SM) AND BLANK FORMS							
<small>PUBLICATION/FORM NUMBER</small> TM 9-1330-200-34						<small>DATE</small> 15 July 1993	<small>TITLE</small> Direct Support and General Support Maintenance Manual for Grenades
<small>ITEM NO.</small>	<small>PAGE NO.</small>	<small>PARA-GRAPH</small>	<small>LINE NO.*</small>	<small>FIGURE NO.</small>	<small>TABLE NO.</small>	<small>RECOMMENDED CHANGES AND REASON (Provide exact wording of recommended changes, if possible).</small>	
<small>* Reference to line numbers within the paragraph or subparagraph.</small>							
<small>TYPED NAME, GRADE OR TITLE</small>				<small>TELEPHONE EXCHANGE/AUTOVON, PLUS EXTENSION</small>		<small>SIGNATURE</small>	

TO: <i>(Forward direct to addressee listed in publication)</i> LRED (AMSRD-AAR-AIL-LS) U.S. Army RDECOM, ARDEC Picatinny Arsenal, NJ 07806-5000	FROM: <i>(Activity and location) (Include ZIP Code)</i>	DATE
--	--	-------------

PART II - REPAIR PARTS AND SPECIAL TOOL LISTS AND SUPPLY CATALOGS/SUPPLY MANUALS

PUBLICATION NUMBER			DATE	TITLE				
PAGE NO.	COLM NO.	LINE NO.	NATIONAL STOCK NUMBER	REFERENCE NO.	FIGURE NO.	ITEM NO.	TOTAL NO. OF MAJOR ITEMS SUPPORTED	RECOMMENDED ACTION

PART III - REMARKS *(Any general remarks or recommendations, or suggestions for improvement of publications and blank forms. Additional blank sheets may be used if more space is needed.)*

TYPED NAME, GRADE OR TITLE	TELEPHONE EXCHANGE/AUTOVON, PLUS EXTENSION	SIGNATURE
----------------------------	--	-----------

The Metric System and Equivalents

Linear Measure

1 centimeter = 10 millimeters = .39 inch
 1 decimeter = 10 centimeters = 3.94 inches
 1 meter = 10 decimeters = 39.37 inches
 1 dekameter = 10 meters = 32.8 feet
 1 hectometer = 10 dekameters = 328.08 feet
 1 kilometer = 10 hectometers = 3,280.8 feet

Weights

1 centigram = 10 milligrams = .15 grain
 1 decigram = 10 centigrams = 1.54 grains
 1 gram = 10 decigrams = .035 ounce
 1 decagram = 10 grams = .35 ounce
 1 hectogram = 10 decagrams = 3.52 ounces
 1 kilogram = 10 hectograms = 2.2 pounds
 1 quintal = 100 kilograms = 220.46 pounds
 1 metric ton = 10 quintals = 1.1 short tons

Liquid Measure

1 centiliter = 10 milliliters = .34 fl. ounce
 1 deciliter = 10 centiliters = 3.38 fl. ounces
 1 liter = 10 deciliters = 33.81 fl. ounces
 1 dekaliter = 10 liters = 2.64 gallons
 1 hectoliter = 10 dekaliters = 26.42 gallons
 1 kiloliter = 10 hectoliters = 264.18 gallons

Square Measure

1 sq. centimeter = 100 sq. millimeters = .155 sq. inch
 1 sq. decimeter = 100 sq. centimeters = 15.5 sq. inches
 1 sq. meter (centare) = 100 sq. decimeters = 10.76 sq. feet
 1 sq. dekameter (are) = 100 sq. meters = 1,076.4 sq. feet
 1 sq. hectometer (hectare) = 100 sq. dekameters = 2.47 acres
 1 sq. kilometer = 100 sq. hectometers = .386 sq. mile

Cubic Measure

1 cu. centimeter = 1000 cu. millimeters = .06 cu. inch
 1 cu. decimeter = 1000 cu. centimeters = 61.02 cu. inches
 1 cu. meter = 1000 cu. decimeters = 35.31 cu. feet

Approximate Conversion Factors

<i>To change</i>	<i>To</i>	<i>Multiply by</i>	<i>To change</i>	<i>To</i>	<i>Multiply by</i>
inches	centimeters	2.540	ounce-inches	Newton-meters	.007062
feet	meters	.305	centimeters	inches	.394
yards	meters	.914	meters	feet	3.280
miles	kilometers	1.609	meters	yards	1.094
square inches	square centimeters	6.451	kilometers	miles	.621
square feet	square meters	.093	square centimeters	square inches	.155
square yards	square meters	.836	square meters	square feet	10.764
square miles	square kilometers	2.590	square meters	square yards	1.196
acres	square hectometers	.405	square kilometers	square miles	.386
cubic feet	cubic meters	.028	square hectometers	acres	2.471
cubic yards	cubic meters	.765	cubic meters	cubic feet	35.315
fluid ounces	milliliters	29.573	cubic meters	cubic yards	1.308
pints	liters	.473	milliliters	fluid ounces	.034
quarts	liters	.946	liters	pints	2.113
gallons	liters	3.785	liters	quarts	1.057
ounces	grams	28.349	liters	gallons	.264
pounds	kilograms	.454	grams	ounces	.035
short tons	metric tons	.907	kilograms	pounds	2.205
pound-feet	Newton-meters	1.356	metric tons	short tons	1.102
pound-inches	Newton-meters	.11296			

Temperature (Exact)

°F	Fahrenheit temperature	5/9 (after subtracting 32)	Celsius temperature	°C
----	---------------------------	-------------------------------	------------------------	----

